



DOMINION & GRIMM



2025/2026

CONTENT

LEGEND



Wood-Fired



Natural Gas



Oil



Propane



Electric

EVAPORATORS

07

Woodfired
Oil/Propane/Natural Gas
Accessories
Electric

RELEASERS

31

Moisture Traps
Pumps
Accessories

SAP GATHERING

55

Tapping
Tubing & Mainlines
Fittings
Tools

BRIX EQUALIZER

21

Brix Balancer Tank
Brix Equalizer Tanks

VACUUM PUMPS

39

Becker
Edwards
Airablo

FINISHING

75

Barrels
Instruments
Cleaners
Accessories

FILTRATION

23

Filter Presses
Accessories
Pumps

MONITORING AND CONTROL

43

Automation
Control
Mapping

PACKAGING & LABELS

84

Jugs
Bottles
Labels
Grading Kits

TANKS

27

Syrup Tanks
Sap Tanks
Silo Tanks

REVERSE OSMOSIS

45

Osmosis Accessories
PH Neutralizer

97

DISTRIBUTION

Authorized Sellers
Corporate Stores



A WORD FROM THE TEAM

Dear Maple Syrup Producers,

Since 1953, Dominion & Grimm has been passionately involved in the field of maple sugaring, a heritage that has been passed down from generation to generation.

Today, thanks to an innovative vision and unique know-how, we offer cutting-edge solutions for maple syrup producers in Quebec, Ontario, the Maritimes and the United States.

Each product we design is the result of many years of experience, listening to the needs of our customers, and having a constant desire for improvement. We combine tradition and modernity, integrating advanced technologies while preserving the authenticity and quality of ancestral methods.

Our team stands out for its strong relationships with our customers, its rigor in manufacturing and desire to always offer reliable and efficient equipment. As a family run company, we bring together proud and passionate people to the team, as we know that a sugar bush is much more than just a workplace; it is a living heritage. This is why we make it a point of honour to provide products that optimize efficiency, durability, and respect for the environment.

On behalf of the entire DG team and the Pepin family, we thank you for being part of this great adventure and for contributing, with us, to perpetuating this precious tradition.

The Dominion Grimm inc. team and the Pepin family



DEEP-ROOTED CRAFTSMANSHIP

At Dominion Grimm, we're committed to preserving our heritage and honing our skills to deliver the superior quality and exceptional finish for which we're renowned.

We apply this expertise to all our product ranges. It's vital for us to ensure that our talents are passed down through the generations. Our craftsmanship comes from over 140 years of experience, which we maintain through numerous in-house training courses,

and on our openness to new technologies. Our ability to innovate makes us a leader in our field. Our ability to maintain, improve and look to the future is ingrained in us and is part of Dominion and Grimm's DNA.





DOMINION & GRIMM
TRADITION DEPUIS 1861

SMALL-SCALE PRODUCERS

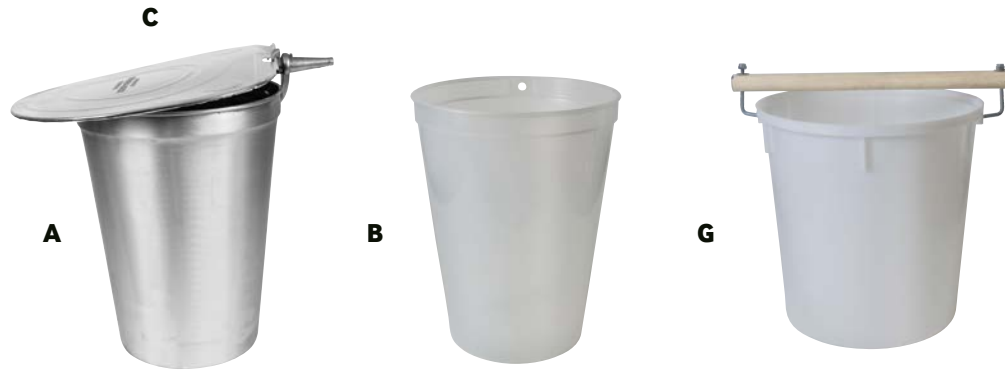

BUCKETS FOR MAPLE SYRUP

- A 470493 2 GALLONS USED ALUMINUM**
- 470516 1.5 GALLONS USED ALUMINUM**
- B 470462 2 gallons plastic, clear (5-year warranty)**

GRIMM COVER

Grimm galvanized covers with rolled edges.

- C 482731 Size: 11 1/4" x 11 5/6"**
- 480119 Replacement wire only**

SPOUTS WITH HOOK

- D 474002 D&G aluminum royal spout 7/16"**
- 473517 Replacement aluminum spout hooks (only)**
- E 428524 5/16" D&G spout**

WOODEN-HANDLE GATHERING PAILS

With EASY-GRIP handle, made in polyethylene.

- 470417 3 gallons**
- G 470431 4 gallons**

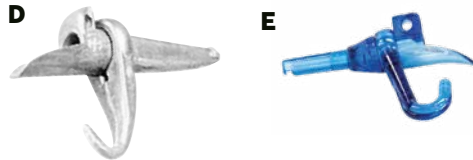

H PRE-FILTER BAG LINERS

Heavy-duty polyester filters. Increase filter bags lifetime.

- 487514 FDA pre-filter n° 8 +/- 100 Microns**
- 487538 Paper square 36" x 36" +/- 100 Microns**

H FILTER BAGS (FDA APPROVED)

- 487767 Polyester n° 8 5 Microns**
- 487781 Polyester n° 8 1 Micron**
- 487828 Polyester 36" x 36" 5 Microns**
- 487804 Polyester 36" x 36" 1 Micron**
- 487330 Felt n° 8 (seamless) 18 Microns**

H



I SUGAR PANS WITH 3/4" OUTLET, STAINLESS STEEL N° 304

Valve not included.

- 206030 12" x 23" x 11" with 3/4" outlet**
- 206092 17" x 23" x 11" with 3/4" outlet on the 23"**
- 206122 17" x 23" x 11" with 3/4" outlet on the 17"**
- 206184 23" x 23" x 11" with 3/4" outlet**
- 216817 Special 3/4" stainless steel ball valve**
- 206481 Pan 16" x 16" x 12" high with 3/4" outlet**
- 206467 Pan 16" x 16" x 12" high with 3/4" outlet and 1/4" outlet for thermometer**

A 18" X 48" WOOD EVAPORATOR

Evaporator designed for 50 taps
18" x 48" flat bottom pan with 3 partitions for sap circulation and valve

Includes: burner box with cast-iron front, smoke stack and pipe
Stainless steel woodfired arch set

B 18" X 8" PREHEATING PAN AND VALVE

C MODEL 94, WOOD BURNING STOVE

Designed for 25 taps, to cook in the cabin.

Furnace model 94 width 26" x 48"

Includes: stainless steel furnace with Cast-iron front burner box, 23" x 23" flat bottom pan with syrup valves, 2x 26" x 12" cast-iron plates with rimmers, Smoke stack and pipe

D 18" X 36" WOOD EVAPORATOR

Evaporator designed for 50 to 150 taps

18" x 24" flue pan with 5" flues

8" x 12" flat bottom finishing pan

Included: burner box with cast-iron front, smoke stack and pipe

7" smoke pipe

PROPANE STOVE FOR BY-PRODUCTS

E 183812 Complete (without lid). Including letters (F,G,I,J)

F 183829 Stove only. Pressure regulator included.
Dimension 16" x 16". 65.000 BTU capacity
Can be connected on any domestic propane tank

G 206481 Stainless steel pan n° 304 16" x 16" x 12" high with 3/4" outlet and adaptor

206467 Bain-marie 16" x 16" with 3/4" outlet and 1/4" outlet for thermometer

H 206511 Stainless steel lid for 16" x 16" pan

I 183836 Stainless steel stand for propane stove with adjustable shelf

J 216817 3/4" Z-p ball valve (Stainless Steel)

K 206535 Griller rack for filters

L 206528 Bain-marie 16" x 16" with 3/4" outlet

ACCESSORIES FOR PROPANE STOVE

461484 No drip 3/4" nylon filler adaptor"

046285 3/4" stainless steel street elbow

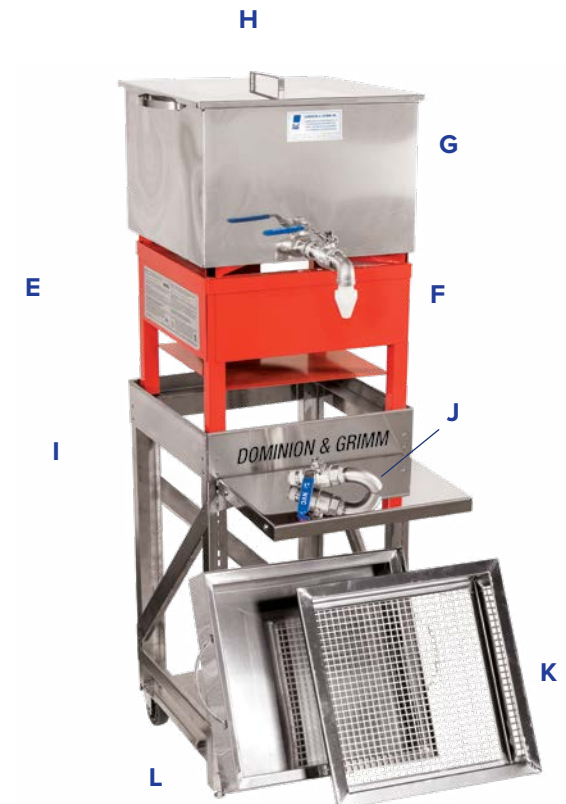
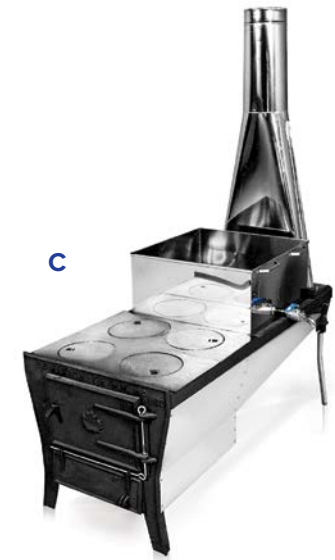

EVERYTHING YOU NEED TO GET STARTED SUGARING

LEGEND



Wood-Fired



Natural Gas



Oil



Propane



Electric

1881

The Sportsman Evaporator has been the gold standard in evaporator technology since its creation in 1881. Dominion & Grimm is proud to uphold the quality.



ENSURE WOOD HAS DRIED FOR AT LEAST 2 YEARS FOR MAXIMUM BTU



THE SPORTSMAN

Wood-Fired
**RECREATIONAL
EVAPORATOR**

FOR A 50-200 TAP MAPLE GROVE

Included: flue pan, syrup pan, float box, syrup ball valve, stainless steel plumbing fittings, thermometer, smoke stack and pipe.

Front side of the burner box made of cast iron, rather than steel.

Available in 18 x 36, 18 x 63 and 2 x 6

OPTIONS

- 085727 Plate 8" x 20" with rimmers #136
- 085758 Full plate 8" x 20"
- 085840 Rimmer Stove 6 1/2" #131

The evaporator pictured includes the option of an 8" x 12" cast iron front plate for improved boiling and cooking



LEARN MORE

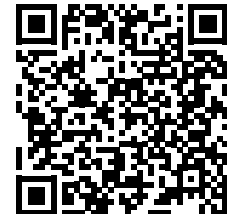



700 SERIES

Wood-Fired
**THE ORIGINAL
 EVAPORATOR** 

MODEL 700

FOR A 150-6000 TAP MAPLE GROVE

The traditional woodfired evaporator. First-quality construction, maintaining D&G's international reputation.

Included: syrup ball valve, drain, stainless steel transfer fittings, float box, dial-thermostat, water-level indicator, stack, pipe and stack cover

Sizes available: 2' x 6' to 6' x 16'

All our woodfired evaporator front sides and doors are made of cast iron. Available with drop flue pans or raised flues. One or several syrup pans (depending on model)

Sizes Available: 2' X 6' TO 6' X 16'

OPTIONS

085789
 085819

Plate 8" x 26" with rimmers
 Full plate 8" x 26"



AIRTIGHT

THE MOST *Vigorous*
WOOD-FIRED
EVAPORATOR IN ITS CLASS



LEARN MORE



Woodfired evaporator with airtight steel door. Improves boiling capacity by up to 15%. Double-walled arch with an extra layer of insulation. Complies with California regulations. Factory-poured high-temperature reinforced concrete in the top of the door. Blower drive to control air flow

Sizes available: 2' x 6' and 7' x 20'

AIRTIGHT LX

The model shown is an automated model



LEARN MORE

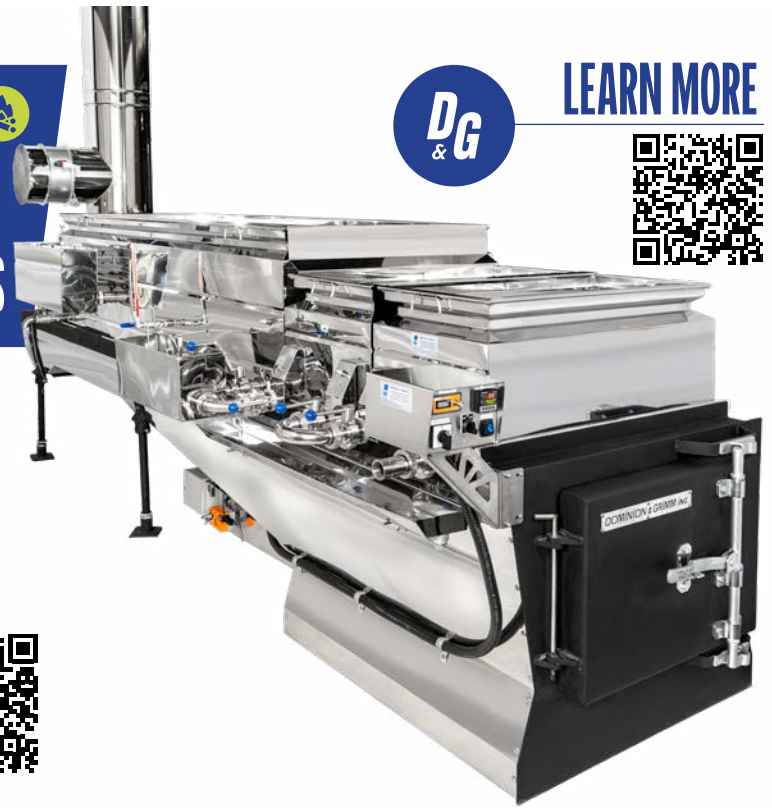

TORNADO

THE MOST ROBUST WOOD
EVAPORATOR IN THE INDUSTRY



Environmentally friendly!

Air injection between 200°F and 400°F all around the periphery to increase combustion.

30% improvement on the boiling rate. Save up to 30% on wood or wood pellets

Possibility of switching from pellets to wood in a few minutes (dual-energy model only).

Double wall system that recovers heat from the combustion chamber and preheats the air injected into the furnace.

Insulation installed at the factory. Factory-poured high-temperature reinforced concrete combustion chamber. Preheated air temperature gauge. Blower drive to control airflow

LEARN MORE

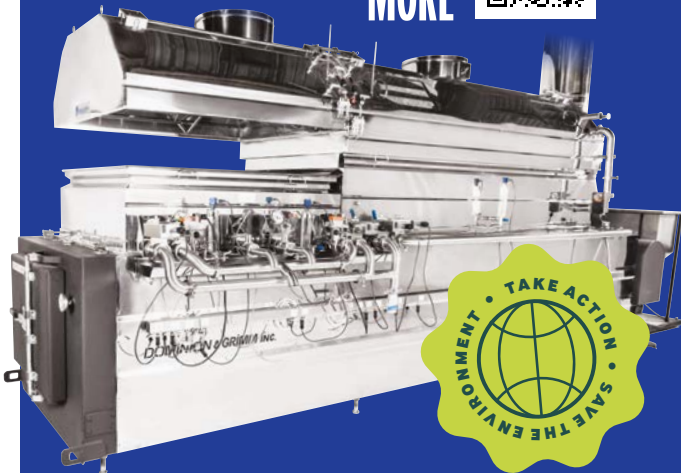

AUTOMATION AVAILABLE

WOOD PELLET HOPPER & GEAR BOX

FOR THE TORNADO EVAPORATOR

Pellets or wood chips are fed to the firebox from the rear, via a specially designed auger that optimizes movement. With rear feed, there are no obstructions in front of or to the sides of the evaporator, allowing free circulation

around it. The Tornado's performance comes from the superior build quality of its reinforced concrete firebox and its insulated compartments allowing hot air to be injected into the combustion box.



NEW & IMPROVED FEED INPUT

LOGS



PELLETS



WOOD CHIPS





CONVENTIONAL

High-Performance
**AT AN AFFORDABLE
 PRICE** 

**CARLIN
 BURNER**

**AVAILABLE SIZES: 18"X63"
 TO 6'X18'**

- High performance evaporator
- High energy efficiency
- Boiling flexibility from 2 to 35 BRIX
- Carlin burner

2 layers of factory-installed no. 8 ceramic wool insulation throughout the evaporator and 1 layer of no.6 ceramic wool

First start-up accompanied by a D&G technician



LEARN MORE

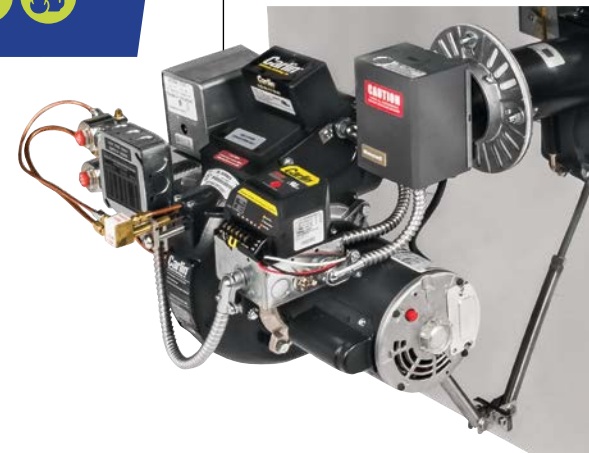

CHAMPION

FROM ONE
GENERATION TO THE
NEXT



1885

Since 1885, its heritage of high performance, aesthetics and superior finish has made the champion the market leader

AVAILABLE SIZES: 2'X8' TO 6'X18

High performance evaporator. Unique streamlined design

High energy efficiency.

Carlin or Powerflame burner

Boiling flexibility from 2 to 35 BRIX

Integrated control panel. Noise insulated burner box. Wiring hidden in the furnace. Syrup recovery tray

Rigid 1" insulation board in the sides of all Champion evaporators

3 layers of factory-installed no. 8 ceramic wool throughout the evaporator

Cooling air chamber all around the evaporator to keep sides safe

Smoke stack thermometer

First start-up assisted by a D&G technician

INSTRUMENTATION

MAGNEHELIC GAUGE

PRESSURE GAUGE (0-200PSI)

BURNER STARTER

110 VOLT ELECTRICAL OUTLET



LEARN MORE



THUNDERBOLT

THE MOST EFFICIENT
EVAPORATOR 
IN THE INDUSTRY

AVAILABLE SIZES: 3'X10' TO 6'X17'

Very high performance evaporator, boiling capacity up to 5.25 gallons per ft²

4 pass heat exchange furnace

High energy efficiency ranging from 80 to 87%

Gas recirculation to maximize the energy of available BTUs

Reduction of greenhouse gases

Power flame burner

Offered in different configurations for Boiling flexibility from 2 to 35 BRIX

Integrated modulating Powerflame burner

Stainless steel 2 level catwalk and 1 step

First start-up accompanied by a D&G technician



LEARN MORE

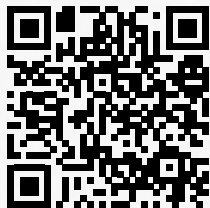

PAN WASHERS

A AUTOMATED POWER WASHER

COMPONENTS:

Tubing assemblies fit between flues in two sections (left and right)

Tubing assembly with spray nozzle for the top flat section of the flues

B Washing tank on pivoting wheels

C Stainless steel ferrules and clamps for easy disassembly

Gould 5hp Wash Pump (100 GPM @ 10 PSI)

3 High Flow modulating valves to control spray velocity

Control box with industrial PLC

Electronic pressure sensor to detect low water levels

ADVANTAGES:

Effectively cleans the bottom and sides of the flues

Large diameter High Flow Spray Nozzle

Strainer filter at the pump inlet above the bottom of the tank

Power supply requirement 230 Volt / 20 Amps (conventional outlet: 230V / 50A)

D STAND ALONE SYRUP PAN WASHER

Pump system to wash your syrup pans

Plexiglas lid

Tank with mesh to recover the limestone

Number of sprinklers varies according to pans size

Available in single, double, triple and quadruple pan format

INTEGRATED SYRUP PAN WASHER

(NOT SHOWN)

Integrated in the pan or tanks

Sold separately

Plexiglas lid

Number of sprinklers varies according to pans size

A



B



C



D



EVAPORATOR ACCESORIES

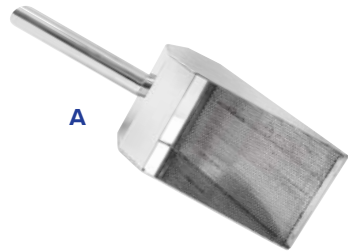

A

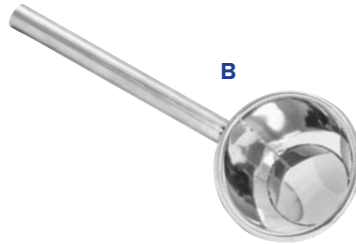

B

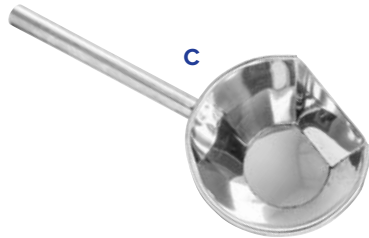

C

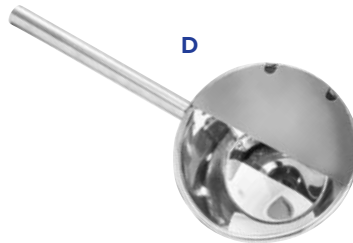

D



E

SKIMMERS STAINLESS STEEL

- A 267482** Perforated 4"
- 267512** Not perforated 4"
- 267420** Perforated 6"
- 267451** Not perforated 6"

DIPPERS STAINLESS STEEL

- B 267147** Round 5"
- 267178** Round 6 1/4"
- 267208** Round 7 1/4"
- C 267055** Flat right side 7 1/4"
- 267086** Flat left side 7 1/4"
- D 267239** Maple taffy dipper with 2 grooves
- 217784** 5" support for dipper
- 217685** 7" support for dipper

E ROUND SUGAR PANS STAINLESS STEEL N° 304

- 206214** 10" x 14" x 5"
- 206245** 12" x 16" x 6"
- 206276** 16" diameter x 16" high

INSULATION ACCESSORIES FOR EVAPORATORS (NOT SHOWN)

- 090820** Refractory fire brick 8 1/4" x 4" x 2 1/2", 2500°F
- 090851** Refractory fire half-brick 8 1/4" x 4" x 1 1/4", 2500°F
- 090882** Refractory mortar 15 lb
- 090929** Refractory mortar 55 lb
- 090943** Soft fire brick (12 per case) 9" x 4 1/2" x 2 1/2", 2300°F
- 089657** Insulation board M Board Kaow 2' x 3' x 1/2", 2300°F
- 091001** Insulation board KFAC 3' x 1' x 1", 1900°F
- 089435** Insulation tape 1/4" x 2"t
- 157431** High temperature sealer for insulation tape 300ml
- 268601** Ceramic insulation ribbon support

INSULATED SMOKE STACK

Stainless steel and insulated wool. Counterpart UL2561
Available in lengths of 12", 24" or 48"

BASE STACK FOR ARCH

24" pipe height

SMOKE STACK (STAINLESS STEEL 304)

Priced per linear foot.

	Diameter		Diameter		Diameter	
252990	7"	253119	14"	253232	22"	
253027	8"	253140	16"	253263	24"	
253058	10"	253171	18"	253294	26"	
253089	12"	253201	20"			

A PEAK STYLE COVER WITH SCREEN

For steam stack or oil-fired arch smoke stack. Made from stainless or galvanized steel.

B TILTING SMOKE STACK COVERS

Including cover and 12" of pipe. Available in stainless or galvanized steel.

C ROOF JACK

Includes a collar to seal the opening between the smoke stack
Made with stainless or galvanized steel
157462 Flashing sealant in 300 ml tubes
157431 High temperature sealant (700°F)

D BAROMETRIC DAMPER (DRAFT CONTROL)

Stabilizes the pressure inside the combustion chamber. Self-adjustment depending of the negative or positive pressure. Required for the proper adjustment of your oil-fired evaporator. Available in many sizes 8" to 24" diameter.

E CAST IRON GRATES FOR WOOD EVAPORATOR

087820	18" x 5" (D-08)	087943	42" x 4" (D-23)
087851	24" x 3" (D-09)	087974	48" x 4" (D93)
087882	30" x 3.5" (D-26)	087981	Concrete grate 11" x 10"
087912	36" x 4" (D96)		

STEAM PIPES (24 GAUGE)

	Hood Width	Diameter
253997	18"	9"
254024	24"	11"
254055	30"	13"
254086	36"	15"
254147	42", 48", 60", 72"	19"

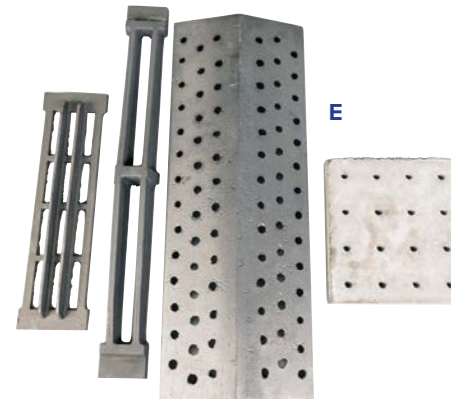
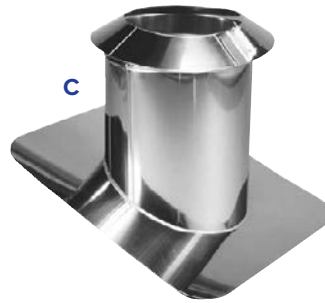

EVAPORATOR OPTIONS



A



B



C



F



D

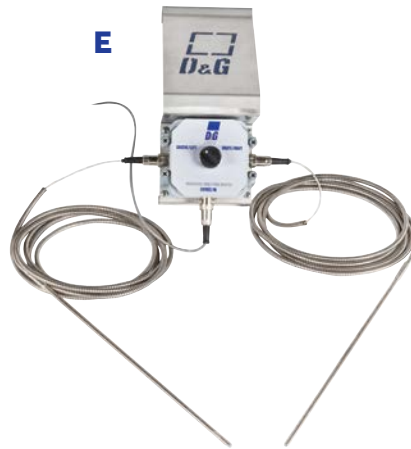

E

A MODULATING AUTOMATIC DRAW-OFF

Fast (4 seconds) and progressive opening and closing with modulating device enables continuous syrup flow and balanced evaporation process.

491795 1" Automatic draw-off

491740 1 ¼" Automatic draw-off

491757 1 ½" Automatic draw-off

491733 2" Automatic draw-off

B 217258 1 ½" x 1 ½" Automatic draw off adaptor

217319 2" x 1 ½" Automatic draw off adaptor

217333 2" x 2" Automatic draw off

C 084010 2" x 2" automatic draw off 2" milk clamp (other sizes available)

D 4.0 MODULATING AUTOMATIC DRAW-OFF

Fast and progressive opening and closing with modulating device enables continuous syrup flow and balanced evaporation process.

Integrated probe inverter (1 probe included).

Communicates with the Brix equalizer to automatically adjust the flow of the evaporator draw off valve according to the desired BRIX.

- Allows to reach a more precise BRIX and reduces labour costs.
- Facilitates and speeds up BRIX balancing, preventing syrup cooling before barreling.

414091 1 ½" Automatic draw-off 4.0

295560 2" Automatic draw-off 4.0

PROBE INVERTER

E 412639 Positioner for 2 syrup controller probes for use with syrup flow inverter. (one probe included)

491580 Controller probe alone

PLUGS

F 212192 1.5" plug with handle, silicon blue (knurled connectors)

212956 2" plug with handle, silicon blue (knurled connectors)

212130 1.5" plug with handle, with o'ring (ferule connectors)

212239 2" plug with handle, with o'ring (ferule connectors)

A FLOW INVERTER

Manual or automated flow inverter
Allows to maintain flow without substituting pans
Center flow capability

EVAPORATOR HOOD (NOT SHOWN)

Stainless steel hood
Full steam energy recovery
Improves evaporator performance
Single or dual function preheater
LED hood lights

B TRANSFERT BOX

216589 Transfer box with sediment trap

C BUTTERFLY VALVES

210501 1 ½" butterfly valve
210136 1 ½" butterfly valve with ferrule
210532 2" butterfly valve
210143 2" butterfly valve with ferrule

D ELECTRIC VALVES

Belimo electric sap entry and transfer valves controlled by level probes. SAP automatically enters the flue pan and is automatically transferred.

DÉTECT-O

Alarm is triggered by low levels of sap in the pans.

E 471001 Detect-o alarm for oil-fired evaporator
(automatic burner cut out, wiring not included)
470998 Detect-o alarm only (for wood-fired evaporator)

DEFOAMER DISPENSERS

Liquid anti-foaming protector for spoke breakdown and flat bottom failure.

Liquid defoamer tank inside hood

Preheated by steam, the defoamer is carried by gravity to the determined locations

Made from 100% stainless steel

202957 Manual defoamer dispenser
280535 Automated electric defoamer dispenser
F 119620 Automated electric defoamer dispenser



ECOVAP



ELECTRICITY FOR SUSTAINABLE DEVELOPMENT



- Environmentally friendly electrically powered technology
- Total recovery of energy contained in maple sap
- No GHG or air contaminant emissions
- Produces traditional syrup taste
- 6 capacities: 80, 160, 225, 340 and 440 GPH
- 2.5 kw per imperial gallon of syrup
- No smoke or steam stack
- Fully automated, resulting in substantially lower labour costs
- Plate heat exchanger and heating elements preheat sap and improve evaporator performance by 25%
- New Power Unit system for 230, 460 and 575 V units
- Proven technology since 2013

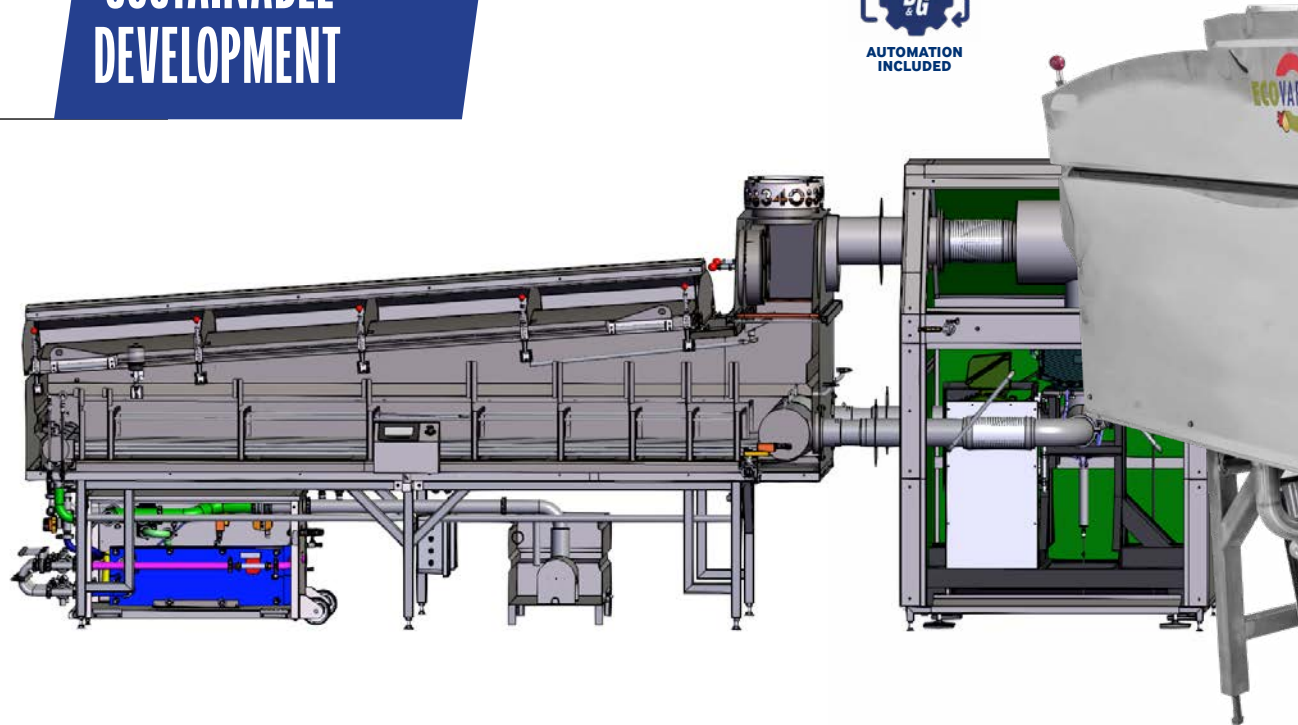

LEARN MORE

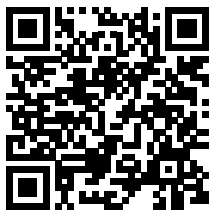

WATCH DEMO

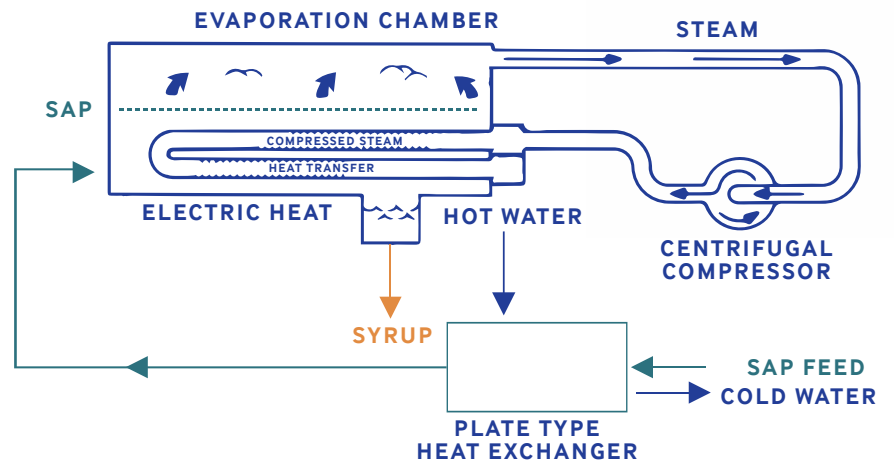



Communicates with the Brix equalizer to automatically adjust the flow of the evaporator draw off valve according to the desired BRIX.

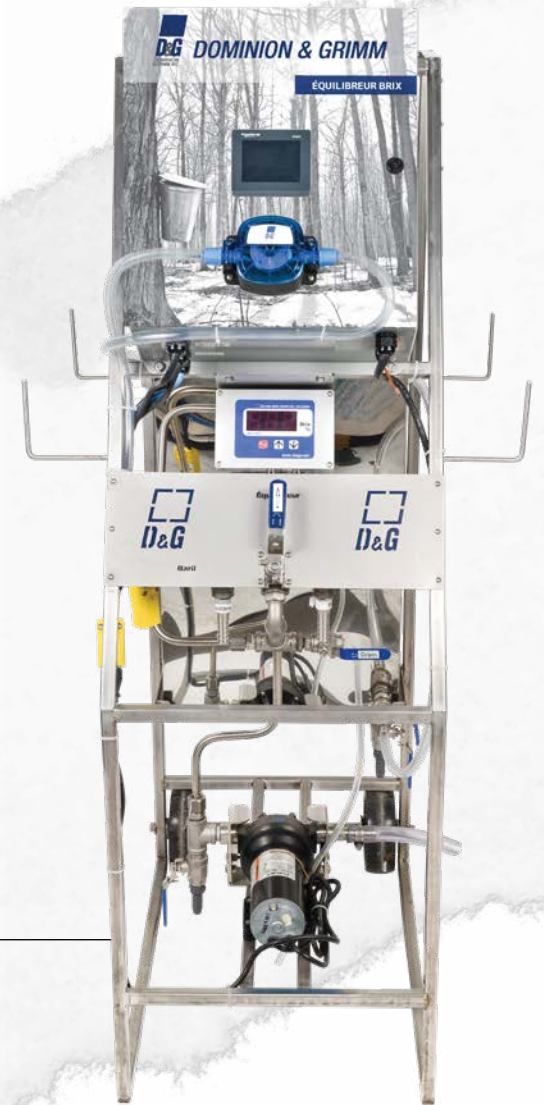

AUTOMATED

BRIX EQUALIZER

LEARN MORE



A 412684 BRIX EQUALIZER

Industrial Schneider programmable touchscreen for start-up, parameter settings and alarms

Automatic and programmable settings for the mixer in the insulated balancing tank

Separate manual start control for pumps and mixer

Management of the external pump for barrel filling (see web site)

Variable metering feed pump for permeate injection in the syrup

6 gallon tank with float for permeate feed

Alert for cleaning the Brix reader

0 to 80 **ATAGO** Brix reader, with integrated temperature sensor

Flojet (6 GPM) circulation pump for barrel transfer

Low-level alarm automatically stops the transfer to barrel allowing consistent Brix and syrup temperature

120 Volt / 15 Amp Power Supply

1 AUTOMATICALLY ADJUST THE FLOW OF THE EVAPORATOR DRAW OFF VALVE ACCORDING TO THE DESIRED BRIX

Allows to reach a more precise BRIX and reduces labour costs

Facilitates and speeds up BRIX balancing, preventing syrup cooling before barreling.

2 AUTOMATICALLY AND PRECISELY BALANCES THE BRIX DEGREE OF SYRUP IN INSULATED TANKS BEFORE BARRELING

Maximizes production income: Each excess BRIX in a 34 gallon tank is equivalent to 0.67 gallons of syrup lost.

Fully automated Brix Equalizing by controlled filtrate injection (easy to operate and intuitive)

3 BARRELING

Rapid barrel filling capacity

Accelerates the syrup barreling and avoids syrup heat loss

3 WAYS TO BARREL

Stainless steel recirculation and transfer pump: Flojet 1/8 hp (6 GPM)

External pump managed by the Brix Equalizer

By gravity

ATAGO REFRACTOMETER CM-800A 0-80 BRIX

B 132933 Continuous ATAGO Brix degree reader for syrup

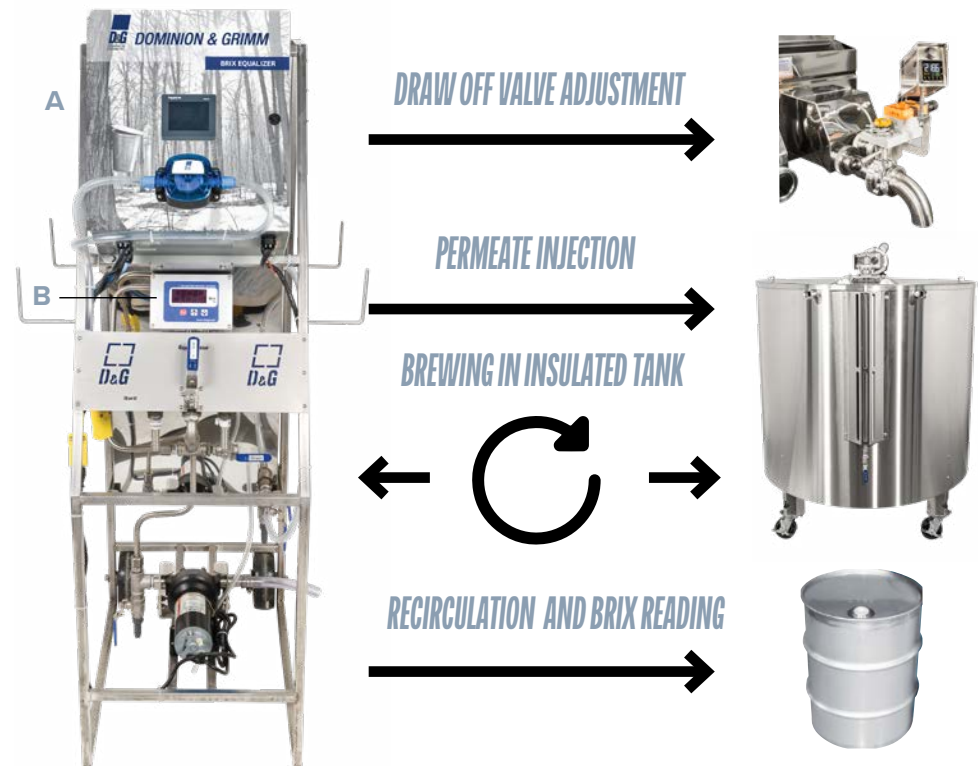

BRIX EQUALIZERS TANKS

ROUND INSULATED TANKS

- A 280986** Insulated tank (250 gallons)
- B 280962** Insulated tank (125 gallons)
Insulated tank to maintain the temperature of the syrup DURING equalizing AND / OR before packaging
2" insulation at R6.8 / inch all around
4" Insulation at R22 / inch at the base
Conical bottom to facilitate outflow
Made of stainless steel
Connections with ferrules
Superior manufacturing quality and durability
Two section lid on hinges
Optional castors
- C 280801** FRAME FOR BRIX TANK (250 gallons)
- D 280900** Ladder for Brix tank
280948 Brix balancer mixer
- E** 1/4 hp - 110/120 Volts motor (21 RPM)
- F** Stainless steel mixing blade



SQUARE INSULATED TANK

- G 262968** Square insulated tank (50 gallons)
2" R6.8 / inch insulation all around and at the base
Completely made of stainless steel
Superior manufacturing quality and durability
Adjustable height
Connections with ferrules
Casters included
Optional heating element and thermostat
Two-part cover with hinges
- 280528** Optional mixing kit (motor, gearbox and mixing blade)
- 280511** Optional heating element and thermostat
- 280542** Optional graduated level



SYRUP FILTER PRESSES

MADE WITH
PRIMARY
ALUMINUM

The best syrup presses on the market

Primary aluminum construction

Top quality finish

Electric diaphragm pump included

Available with 7 or 10
frames 2 inches thick

Also available with a
pneumatic diaphragm pump

DOMINION & GRIMM

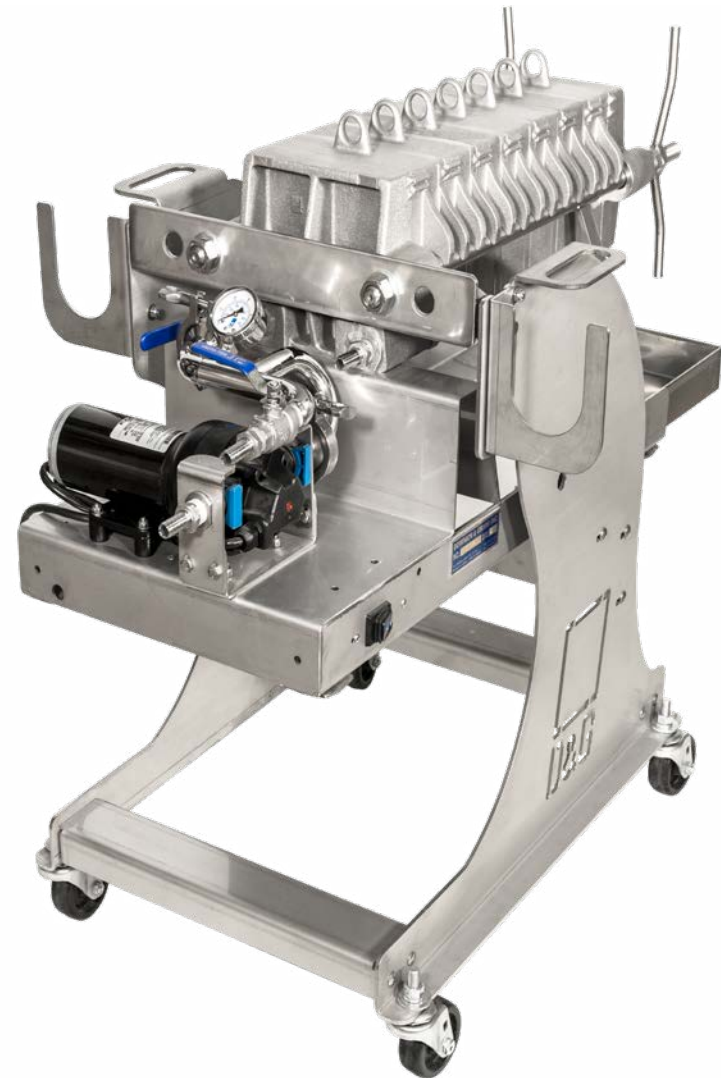

7" SYRUP FILTER PRESSES

Capacity of 80 in³ of filtration per empty frame.

264719 Complete (7 frames) with 6 GPM 1/8 hp Flojet diaphragm electric pump

420009 Complete (7 frames) with 1/2" Allflow pneumatic diaphragm pump

264771 Complete (3 frames) with 6 GPM 1/8 hp Flojet diaphragm pump
Flojet pump and plumbing adapted for filter press

265099 Complete (3 frames) with 1/2" Allflow diaphragm pneumatic pump
Also available with 4, 5, or 6 2" thick frames. Optional tilting support.



10" DIAPHRAGM SYRUP FILTER PRESSES

Capacity of 187 in³ of filtration per empty frame.

- 264136** Complete (7 frames) with 6 GPM 1/8 hp Flojet electric diaphragm pump
- 433085** Complete (7 frames) with 1/2" diaphragm Allflow pneumatic pump
- 265402** Extended complete (10 frames) with 6 GPM 1/8 hp Flojet diaphragm electric pump
- 265396** Long complete (10 frames) with 1/2" diaphragm Allflow pneumatic pump

 **Now Available**
With Electric Pump



15" DIAPHRAGM SYRUP FILTER PRESSES

Ideal for 15 000 to 30 000 taps and more. Capacity of 415 in³ of filtration per empty frame. Manufactured in aluminum. Removable stainless steel plumbing with ferrule. Hydraulic system to tighten the plates. High quality finish.

- 264528** Syrup press (complete with 7 frames)
- 264542** Syrup press (complete with 10 frames)

20" DIAPHRAGM SYRUP FILTER PRESSES

Ideal for 25 000 taps and more. Capacity of 920 in³ of filtration per empty frame. Manufactured in aluminum. Removable stainless steel plumbing with ferrule.

Hydraulic system to tighten the plates. High quality finish.

- 264856** 20" Syrup filter press complete (7 frames)
- 265211** 20" Syrup filter press complete (10 frames)
- Included single air inlet to supply the diaphragm pump and hydraulic cylinder
- 385551** Plumbing kit with ferrules for diaphragm pump
- 265457** Black hydraulic cylinder with pedal (industrial)

FILTER PRESS ACCESSORIES

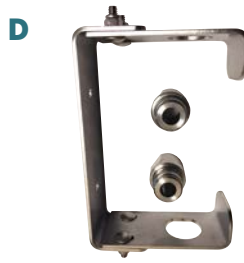

6 GPM (GALLONS/MINUTE) FLOJET PUMPS

Flojet Diaphragm pump, NSF approved
 Made of nylon
 1/8 hp integrated motor
 6 gallons/minute pump (GPM)
 Maximum pressure of 50 PSI
 Can replace your Oberdorfer 1/2" brass pump

- A 385964** Pump, assembled on a stainless steel frame
- B 385940** Flojet Pump only

FLOJET COMPLETE KIT

385568 Includes (C - D - E) :
 Flojet 6 gallons electric diaphragm pump only
 Stainless steel plumbing kit
 Stainless steel frame and stand kit with 1/2" adaptors (parts may be sold separately)

C FLOJET PUMP COMPLETE PLUMBING KIT

385582 Plumbing kit necessary to replace the Oberdorfer pump. Includes miscellaneous plumbing items and a 0-100 PSI dial for the Flojet pump

D FLOJET PUMP FRAME KIT

385575 Includes the stainless steel frame and the stainless 1/2" pump adaptors, bolt and o-rings (2x)

FOOD GRADE GREASE (NOT SHOWN)

477515 Cartridge – 400g

E DIAPHRAGM PUMPS FOR FILTER PRESSES

These pumps require an air compressor.

- 159923** 1/2" Aluminum diaphragm pump for 7" or 10" press
- 159916** 1" Aluminum diaphragm pump for 15" or 20" press

ACCESSORIES FOR SYRUP FILTER PRESSES

- 485343** Filter aid 50 pounds "Dicalite"
- 485619** Set of 7" D&G white papers 400/box (20 microns)
- 485633** Set of 10" D&G white papers 400/box (20 microns)
- 487477** Set of 15" D&G white papers 250/box (20 microns)
- 485626** Set of 20" D&G white papers, 250/box (20 microns)
- 487323** Set of 7 3/4" Leader white papers, 400/box
- 487460** 15" polyester filter for D&G press
- 487453** 15" polyester double press filter
- 487484** 20" Polyester filter for D&G press

- A 080791** 0-100 PSI Pressure Gauge (Lead free brass)
- B 080838** 0-100 PSI D&G Pressure gauge, stainless steel

ROCKING SUPPORTS

- C 265495** Rocking support for 7" and 10" press (painted blue)
- D 265327** Stainless steel rocking support for 7", 7" short & 10" presses

E SYRUP PRESS SEPARATORS WITH STAINLESS STEEL HANDLE

Prevents the press from getting completely dirty if you have only a small quantity of syrup to filter. Separates the frames of the press. Saves time and paper filters

- 264566** 7"
- 265150** 10"
- 265792** 15"
- 265808** 20"

INSULATED COVERS FOR FILTER PRESSES

- 266515** Cover for 7" presses (3 frames)
- 266140** Cover for 7" presses (7 frames)
- F 266133** Cover for 10" presses (7 frames)
- 266430** Cover for 15" presses
- 266126** Cover for 20" presses

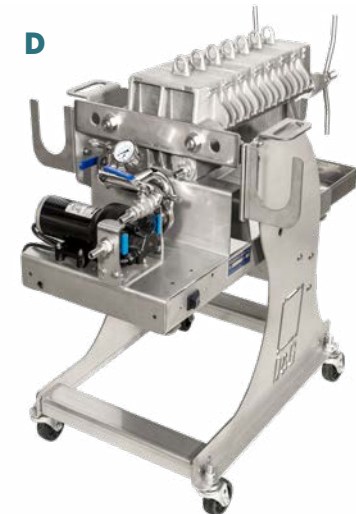
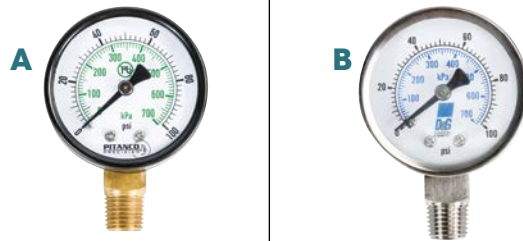

SYRUP TANKS



SYRUP DUMPING TANKS OR SYRUP DRAW-OFF CONTAINERS

Compartmentalized tanks to separate the syrup pan liquid from each pan during the cleaning or when switching syrup pans. Allows you to pump back the syrup pan concentrated liquid without mixing it from one pan to another. Plumbing system and valve to pump back into the syrup pan(s). Can be used as a syrup draw-off container.

270901 Tank, 2 compartments 25 gallons (not shown)
Also available in 20, 33, and 40 gallons

A 270932 Tank, 3 compartments 25 gallons
Also available in 40 gallons
Pump available as an option

STAINLESS STEEL SYRUP DUMPING TANKS OR SYRUP DRAW-OFF CONTAINERS

B 270987 Tank, 2 compartments 25 gallons
Also available in 20, 33, and 40 gallons

271014 Tank, 3 compartments (not shown)
Also available in 40 gallons
Pump available as an option

STAINLESS STEEL CONTAINERS FOR MAPLE

Container in stainless steel n° 304 with lid

C 523342 30 litres

D 523373 40 litres

E 523359 50 litres

208843 ¾" Female welded adaptor

COMPLETE SYRUP FILTERING CONTAINERS

Complete with lids. Supplied with ¾" valve, polyester, and hole adaptors for holding filter.

262739 10 gallons, 1 polyester

262746 15 gallons, 1 polyester

262777 20 gallons, 2 polyesters

262807 40 gallons, 3 polyesters

INSULATED SYRUP TANKS WITH LIDS

262838 12 gallons

F 262814 20 gallons

G 262821 40 gallons

262808 40 gallons, 3 polyesters



SYRUP DRAW-OFF CONTAINERS WITH LIDS

Stainless steel n° 304. Valves not included.

- A 262623** 6 gallons, 22" height x 9" diam.
- B 262630** 10 gallons, conical bottom, 25" height x 12" diam.
- C 262654** 15 gallons, conical bottom, 25" height x 16" diam.
- D 262685** 25 gallons, conical bottom, 25" height x 20" diam.
- E 262715** 50 gallons, conical bottom, 30" height x 23" diam.
- 216817** Z-P 3/4" stainless steel ball valve
- 216787** Z-P 1/2" stainless steel ball valve
- 263217** 1-hole adapter for 10-gallons syrup container
- 263224** 1-hole adapter for 15-gallons syrup container
- F 264122** Syrup container ring

SUPPORTS WITH WHEELS FOR SYRUP CONTAINERS

Steel Painted Blue

- 262265** Round 9 gallons (12" diameter)
- 262227** Round 12 gallons (16" diameter)
- 262258** Round 20 gallons (20" diameter)
- 262289** Round 40 gallons (23" diameter)

Stainless Steel:

- 262296** Round 9 gallons (12" diameter)
- 262302** Round 12 gallons (16" diameter)
- G 262319** Round 20 gallons (20" diameter)
- 262326** Round 40 gallons (23" diameter)

H STAINLESS STEEL PADDLE FOR SYRUP CONTAINERS

- 267307** To stir the syrup in the containers (measures 48" long)

PRE-FILTER BAG LINERS

Heavy-duty polyester filters. Increase filter bags lifetime.

- I 487514** FDA pre-filter n° 8.....+/- 100 Microns
- J 487538** Paper square 36"x36".....+/- 100 Microns

FILTER BAGS (FDA APPROVED)

- K 487767** Polyester n° 8.....5 Microns
- L 487781** Polyester n° 8 1 Micron
- M 487828** Polyester 36" x 36".....5 Microns
- N 487804** Polyester 36" x 36".....1 Micron
- O 487330** Felt n° 8 (without stitches).....18 Microns



SAP TANKS

**ULTRA-STRONG
STEEL STRUCTURE**

A ROUND BOTTOM TANKS

Round bottom tanks, 100 to 9000 gallon capacity, stainless steel 304-2B (Dull) or 304 (Bright), 22ga or 20ga depending on the size.

274275 Customized tagging on tank available

B INTERIOR TANK LADDER

289705 Ladder for 7' and 7 1/2' tanks

SILICON PLUGS FOR TANKS

(NOT SHOWN)

402418 1 1/2" DFA tank plug

402425 2" DFA tank plug

402487 3" DFA tank plug

C PLASTIC TANKS FOR SAP

Plastic sap storage tank with wide stainless steel opening and stainless steel cover.

473166 65 U.S. gallons (23" x 43" x 26") 12.5" opening

473203 125 U.S. gallons (32" x 41" x 35") 16 1/4" opening

473128 225 U.S. gallons (38" x 41" x 49") 16 1/4" opening

473142 16 1/4" stainless steel mesh



SAP SILOS

OPTIONS

- 433702** Top access hatch
- 433719** Ladder
- 433726** Flap to restrict ladder access
- 433740** 3" auxiliary output
- 433757** Non return valve
- 433764** Overflow insect screen

INCLUDES

- Cleaning Ball
- Anchoring plates
- Lower Access Trap
- Air Vent
- 2" Inlet and Overflow
- Two 3" Outlets superposed by 10"
- Slopped bottom for easy drainability

		DIAMETER (FEET)		
		8'	10'	12'
HEIGHT (FEET)	8'	2426 Imp. Gal. (11032 L) #434738		
	10'	3052 Imp. Gal. (13878 L) #434739		
	12'	3678 Imp. Gal. (16725 L) #434740	5746 Imp. Gal. (26132 L) #445192	
	15'	4616 Imp. Gal. (20995 L) #434741	7213 Imp. Gal. (32804 L) #445194	10386 Imp. Gal. (47238 L) #433641
	20'	6181 Imp. Gal. (28112 L) #434742	9658 Imp. Gal. (43924 L) #445200	13907 Imp. Gal. (63251 L) #433658
	25'	7746 Imp. Gal. (35229 L) #434743	12103 Imp. Gal. (55044 L) #445217	17428 Imp. Gal. (79264 L) #433665
	30'	20948 Imp. Gal. (95277 L) #433672		
	35'	24469 Imp. Gal. (111289 L) #433674		
40'	27990 Imp. Gal. (127302 L) #433676			

**NEW SILOS MANUFACTURED
BY DOMINION & GRIMM**

NEW



RELEASERS

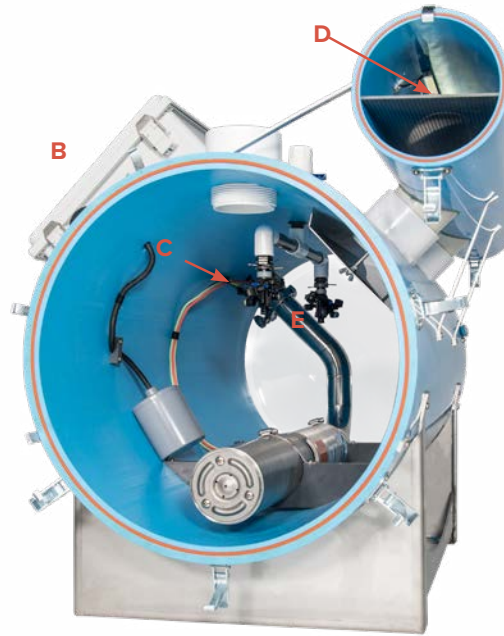

Relaser model is determined by the number of taps and the amount of vacuum needed

ELECTIC RELEASER WITH SUBMERSIBLE PUMP

For sugar bush with 100 to 30 000 taps. 1.5 hp pump is installed within the releaser. Easy to operate. Can release water with a vacuum of 27 Hg and up with no vacuum interruption, and a 2" output.

Capacity of 2300 to 7000 taps (1 or 2 pumps, 0.5 hp)

- A 484421** Vertical 10" x 30", 110 volts (DG-224-PS)
Manifold height 32"
- 388873** Horizontal 14" x 30", 110 volts (DG-223-30PS)
Manifold height 22,5"
- 485916** Horizontal 18" x 24", 110 volts (DG-225-PS)
Manifold height 25,5"
- 484728** Horizontal 18" x 24", 110 volts (DG-225-2PS)
Manifold height 25,5"
- 436178** 1/2 submersible pump option, 230 volts
Can replace 1/2 pump, 100 volts in abovementioned models for greater water extraction capacity if required

Capacity of 4000 taps (1 pump 1 hp)

- 484346** Horizontal 14" x 36" (DG-223-PS)
– Entrée des collecteurs à 22,5" du sol

Capacity of 2300 taps (1 pump 0,5 hp)

- 487286** Horizontal 14" x 36", 230 volts (DG-223-36S)
Manifold height 22,5"

B Capacity of 7000 taps (1 pump 1.5 hp)

- 407468** Horizontal 18" x 36" (Dg-227-PS)
Manifold height 22,5"

Capacity of 8000 taps (1 pump 2 hp)

- 407475** Horizontal 18" x 48" (Df3-227-PS 2HP)
Manifold height 22,5"

Capacity of 8000 taps (2 pumps 1 hp)

- 484858** Horizontal 18" x 36" (D(p-223-2PS)
Manifold height 22,5"

Capacity of 70000 a 16000 taps (2 pumps)

- 407512** Horizontal 18" x 36" (DG 227-2PS)
486210 Horizontal 18" x 48" (Dg227-2PS x 2 HP)
Manifold height 22,5"

C SPRINKLER TO WASH THE RELEASER

- 409226** Sprinkler set for 24 inch releasers
409417 Sprinkler set for 36 inch releasers
Model operated under vacuum

By sucking water from your tank, the sprinkler cleans the walls of your releaser

Optional or included on your new releaser
Fits on your current releaser
Also available for mechanical releaser

D SET OF LED LIGHTS

- 487217** Set of LED lights for releaser
487244 Set of LED lights for double releaser
Ideal to improve vision inside the manifold

E STAINLESS STEEL SUBMERSIBLE PUMP OUTLET

- 487200** Stainless steel outlet kit for submersible pump

F ELECTRIC SUBMERSIBLE MULTI-PUMP RELEASER

Capacity of 25 000 taps
484438 (DG-227-PSM) 4 pump model
Horizontal model 18" X 60" with 2 cylinders
Manifold height 44"
Available in 2, 3 or 4 pumps configurations depending on the number of taps

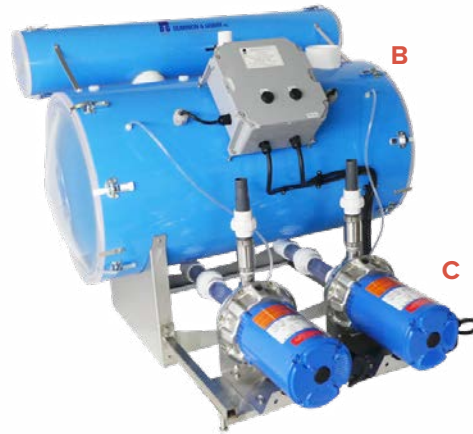
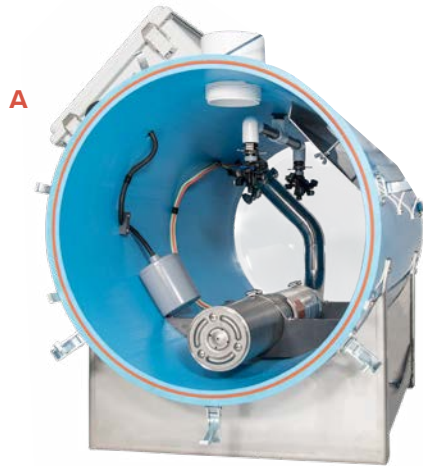

Now with internal level float to operate the pump



A ELECTRIC ECONOMIC RELEASER

- 436352** Electric Vertical, 10x 30, 1/2 hp pump 110 volts – 244-PS Eco
- 436345** Electric Horizontal, 14 x 30, 1/2 hp pump 110 volts – 223-30 Eco
- 484353** Electric Horizontal, 18 x 24, 1/2 hp pump 110 volts – 225-PS Eco
- 436338** Electric Horizontal, 18 x 24, 2 sub pump, 1/2 hp 110 volts – 225-2PS Eco
- 436321** Electric Horizontal, 14 x 36 sub pump, 1 hp – 223-PS Eco
- 436369** Electric Horizontal, 18 x 36, 2 sub pump, 1 hp – 223-30 Eco
- 409370** Electric Horizontal, 18 x 36 sub pump, 1,5 hp Econo – 227-PS Eco
Electric Horizontal, 18 x 36, 2 sub pump, 1,5 hp Econo – 227-2PS Eco.
Input varies depending on the releaser model

B HORIZONTAL ELECTRIC DUAL-PUMP RELEASERS

- For 4000 - 20 000 taps (the number of pumps used varies according to the number of taps)
- 484339** (DG-223-36) 14" x 24" 2 penn switch, manifold height 26.5"
 - 400766** (DG-227-36) 18" x 36" 2 penn switch, manifold height 29.5"
 - 400605** (DG-227-48) 18" x 48" 3 penn switch, manifold height 29.5"

System uses two water pumps
Second pump serves as backup if first pump is insufficient
–"Gould" pumps can extract water from the sap to a vacuum of 27 Hg and higher
Pump and stand not included

C RELEASER STAND FOR WATER PUMP

Available for 1, 2 or 3 water pumps

D HORIZONTAL ELECTRIC SAP RELEASERS (1 PUMP)

- | | |
|---------------------------------------|----------------------------------|
| Capacity of 4000 taps | Capacity of 5000 taps |
| 486173 14" x 24" (DG-223) | 400452 18" x 24" (DG-225) |
| Manifold height 26.5" | 400544 18" x 36" (DG-227) |
| Requires a water pump to dump the sap | |
| Manifold height 29.5" | |

E VERTICAL ELECTRIC SAP RELEASERS

- | |
|---------------------------------------|
| Capacity of 1500 taps. |
| 400391 10" x 24" (DG-224) |
| Capacity of 2500 taps. |
| 400421 10" x 36" (DG-224-1) |
| Requires a water pump to dump the sap |
| Manifold heights: |
| For 1500 taps (25") |
| For 2500 taps (38") |

The model of the releaser is determined by the number of taps and vacuum level



All sap releasers are factory tested and checked



CONTINUOUS VACUUM

A VERTICAL MECHANICAL SAP RELEASERS

Capacity of 700 taps.

400278 (DG-216) 10" x 18"

Mechanical releaser

Installed above small storage tank

Manifold height: 20"

B DOUBLE VERTICAL MECHANICAL SAP RELEASERS

Capacity of 3000 taps.

400186 10" x 18" (DG-213-18) Manifold 18"

400407 10" x 24" (DG-213-24) Manifold 24"

Continuous vacuum mechanical sap releaser

Installed on a storage tank

The sap is alternately dumped in, one side at a time

Manifold height 20"

C HORIZONTAL MECHANICAL SAP RELEASER

Capacity of 2500 taps.

400926 10" x 18" horizontal (DG-213H)

Continuous vacuum releaser

Installed on a storage tank

The sap is alternately dumped in, one side at a time

Manifold height: 16.5"

D DOUBLE HORIZONTAL MECHANICAL SAP RELEASERS

Capacity of 2500 taps.

407956 10" x 36" (DG-214)

Capacity of 6000 taps

400476 14" x 36" (DG-219)

Capacity of 12 000 taps

400308 18" x 36" (DG-220) Vacuum inlet 2"

400360 18" x 48" (DG-222) Vacuum inlet 3"

Continuous vacuum mechanical sap releasers

Installed on a storage tank

The sap is alternately dumped in, one side at a time

Manifold heights

For 2500 taps (16.5")

For 6000 taps (22.5")

For 12 000 and 25 000 taps (26.5")

E GUIDE ROD FOR RELEASER

Improved rod guide with seal for high vacuum (27 Hg and over)

Improves the tightness of the device

Installs on any new device and existing ones

When installed as an add-on, the replacement of the float rod is mandatory when installing the guide

Daily maintenance required



B



C



MECHANICAL RELEASERS WITH DOUBLE SINGLE VALVES

- Capacity of 3000 taps.
A 400896 10" x 18" (DG-213-2VS) Vertical
- Capacity of 6000 taps.
B 400865 14" x 36" (DG-219-2VS)
- Capacity of 12 000 taps.
406928 18" x 36" (DG-220-2VS) Vacuum Inlet 2"
406911 18" x 36" (DG-220-3-2VS) Vacuum Inlet 3"
- Capacity of 25 000 taps.
406898 18" x 48" (DG-222-2VS) Vacuum Inlet 3"

Releasers allowing an even more constant continuous vacuum.
 Allows a bigger volume of sap at a high vacuum
 Installed on a sap tank, they evacuate the sap mechanically (without pump) simply by vacuum

Manifold heights:
 For 3000 taps (20")
 For 6000 taps (22.5")
 For 12 000 and 25 000 taps (26.5")

C AUTOMATED MECHANICAL RELEASERS

- Capacity of 2500 taps.
487248 10" x 24" (DG-213B)
487279 10" x 36" (DG-214B)
- Capacity of 6000 taps.
407987 14" x 36" (DG-219B)
- Capacity of 12 000 taps.
407970 18" x 36" (DG-220B)
- Capacity of 25 000 taps.
407963 18" x 48" (DG-222B)

New generation of mechanical releasers
 Eliminates any loss of air when sap is dumped into the tank
 Sap sensors are connected to **BELIMO** (5-year guarantee) valves to ensure tightness of the releaser

Manifold heights:
 For 2500 taps (16.5")
 For 6000 taps (22.5")
 For 12 000 and 25 000 taps (26.5")



WATCH DEMO





**HIGH
VACUUM**



A CONVENTIONAL MOISTURE TRAPS

400773 8" x 30" Model (Vacuum 1.5 hp)

400827 10" x 24" Complete Model
(Vacuum 5 hp and under)

Options:

400735 Moisture trap only

400711 Aluminum base

485893 Water level sensor for emergency stop

400834 Complete 14" x 30" model
(Vacuum 7.5 hp) and up

Options:

400636 Moisture trap only

400704 Aluminum base

485893 Water level sensor for emergency stop

B DELUXE MOISTURE TRAPS

Includes filtering devices for water particles

Water level sensor to stop the pump in case of failure

409295 Deluxe D&G 14" x 30" moisture trap for
Becker pump (recommended) 7.5 hp and more

404108 Deluxe 10" x 24" moisture trap D&G

D&G SAP LIFTERS WITH MANIFOLD

Single (up to 350 taps).

C 400582 Sap lifter with manifold (DG-555)

Double (up to 800 taps)

D 400599 Sap lifter with manifold (DG-555-2)

Requires high-level vacuum (20 to 29 Hg)

Makes it possible to collect sap from trees on sites lower
than the main pumping station. Maximum elevation drop of
15 feet

We recommend the installation of this unit in a temperate
place between 1° and 5° Celsius to avoid frost

FDA BLUE FLAPPERS FOR RELEASERS

E 403156 2" small

F 403125 3" large

G 403187 3" with spring and hinge (specify releaser model)

VACUUM GAUGE (LEAD-FREE)

116261 2.5" dia. 0 30 Hg, lead-free brass

371462 4" dia. 0 30 Hg, lead-free brass

080104 2.5" dia. 0 30 Hg, stainless steel

H 080128 4" dia. 0 30 Hg, stainless steel

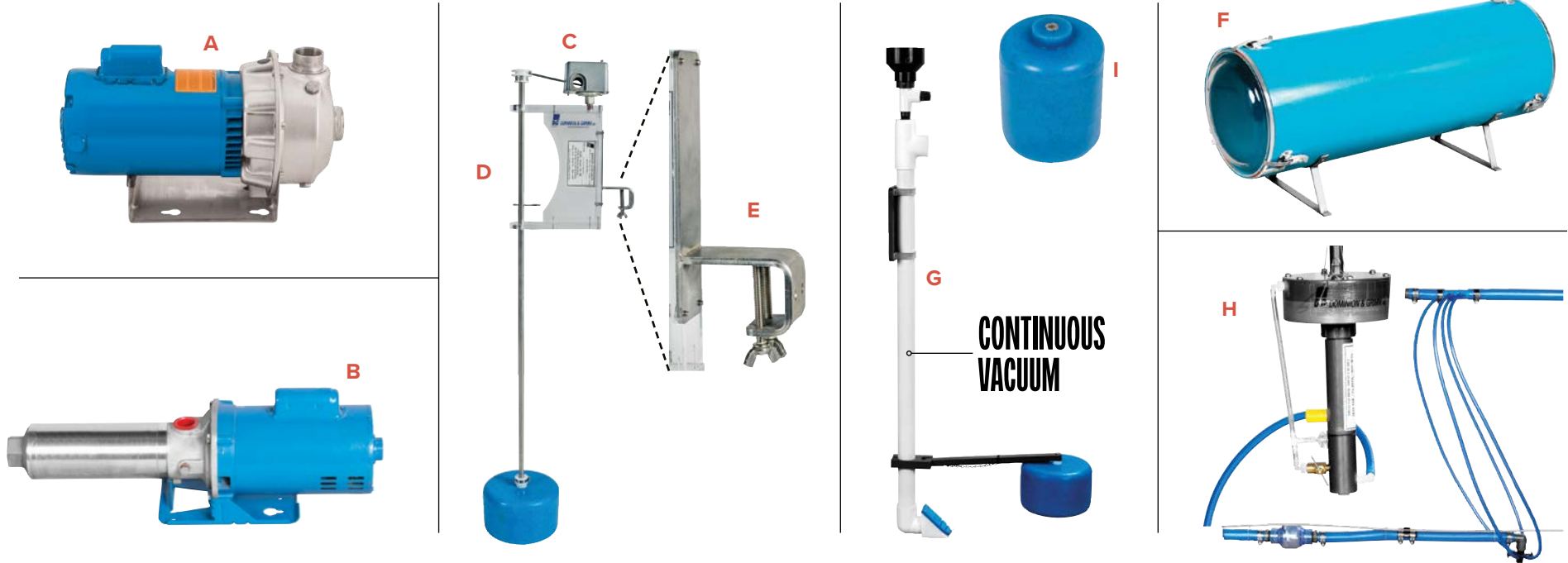

A 1 PH -230 V-ODP GOULD PUMPS

Made of stainless steel. 2- and 3-stage pumps also available.

- 385001** ¾ hp 1ST **385049** 3 hp 1ST
- 385032** 2 hp 1ST **385025** 1.5 hp 1ST
- 385018** 1 hp 1ST

B GOULD HI-PRESSURE MULTISTAGE PUMPS

125 to 350 PSI, 5 gallons and more per minute, ½ to 5 hp.
See our in-store representatives for your specific needs

C RELEASER PENN SWITCH

401923 (DG-430)

D ELECTRIC CONTROL FOR STORAGE TANK

Starts water pump. Used to transfer sap to another tank. Volume to be transferred is also adjustable.

401985 (DG-432)
Other rod lengths also available

E STAINLESS STEEL FLOAT TANK SUPPORT

402579 Stainless steel support for electrical control for storage tank (See letter D)

F HORIZONTAL VACUUM BOOSTERS

Helps vacuum transport on long distances from the sugar bush and enhances vacuum performance in the lines.

Without support	With support
400872 6" x 12"	358692 10" x 24"
400902 6" x 18"	358166 10" x 30"
400933 6" x 24"	358708 10" x 48"
401046 3" x 24"	358197 10" x 60"
409684 O-ring joint for 10" booster	
403453 Orange O-ring joint \$/per foot	

G INVERSE SLOPE PUMPING SYSTEM

Allows sap to flow from a remote pumping station to the main sap releaser (sugar bush). To be installed with a mechanical releaser storage tank. Enables sap to flow by gravity when the vacuum pump is shut down.

403934 (DG-520)

H AIR INJECTOR SYSTEM

Air injector system increases sap flow toward the main sap releaser. Also optimizes sap ladder operation and helps sap rise.

405426 Air injector system (DG-510)
(for check valves see pg. 64)

I RELEASER FLOATS

402227 Small blue
402524 Large

MOISTURE TRAPS



B



C



D



E



F



A ANTI-FRAZIL PVC MESH

- 408144** For manifold 6" x 12"
- 408175** For manifold 6" x 27"
- 408151** For manifold 6" x 18"
- 408182** For manifold 6" x 38"
- 408168** For manifold 6" x 24"
- 401138** Other sizes available (\$/foot²)

B SWIVELS FOR MECHANICAL SAP RELEASER

- 403965** 1½"
- 403996** 2"
- 404023** 3"

C 404733 Grease pack (3 ml)

HEIGHT ADJUSTABLE RELEASER STANDS (NOT SHOWN)

- 274510** For 48" tank (set of 2)
- 274541** For 84" tank (set of 2)
- 274527** For 60" tank (set of 2)
- 274558** For 90" tank (set of 2)
- 274534** For 72" tank (set of 2)

D HEIGHT AND LENGTH ADJUSTABLE RELEASER STANDS

- 274589** 3' to 5' (set of 2)
- 274596** 4' to 7½' (set of 2)

RELEASER STANDS (NOT SHOWN)

Made of stainless steel 18 gauge. Use to hold the pneumatic releaser above the tank.

- 274404** For 48" tank (set of 2)
- 274411** For 60" tank (set of 2)

OTHER SIZES AVAILABLE

E CYLINDERS FOR RELEASERS

- 402395** Cylinder for releaser (DG-216)
- 401565** 2½" cylinder for releaser (DG-213)
- 401657** 3" cylinder for releaser (DG-215,219,220)
- 401688** 4" cylinder for releaser (DG-220-3,222)

F VULCANIZED SEALING JOINTS

- 403415** For releaser DG-213
- 403408** For releaser DG-216
- 403521** For releaser DG-224,224-1

OTHER SETS AVAILABLE FOR ALL RELEASER MODELS

VISIT OUR UPDATED WEBSITE

Stay tuned for exciting new features and updates arriving throughout the year. Remember to visit our website for the latest news and exclusive sales.

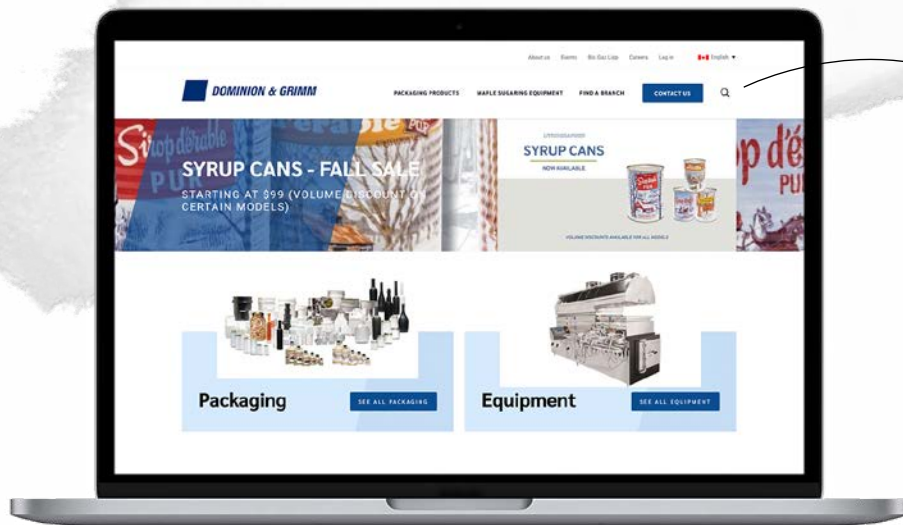

NEW



MAPLE SYRUP HISTORY

Explore the evolution of maple syrup production, from yesterday to today, through a host of elements from various players in the field. You will find several images, anecdotes and historical facts about maple syrup.

493874 Histoire Acéricole: Anecdotes, Procédés techniques, Chalumeaux

**English version coming early 2025*

VACUUM PUMPS



A BECKER OIL-COOLED PUMPS

Oil-cooled pallet vacuum pump	Direct drive shaft
Vibration isolator	Available in all voltages
Up to -29.5 Hg	Ultra quiet
3, 5, 7.5 and 10 hp models	Stand and drive not included
	Without overheating

B YASKAWA SMART SPEED MODULATOR

For vacuum pump
 Smart drive kit including a temperature and vacuum probe
 Controls the vacuum level as needed
 Modulation between -15 and -29.9 Hg
 Motor start, stop and speed adjustment according to temperature setting
 Adjust the vacuum and temperature settings yourself
 Once the desired vacuum is reached, the speed modulator slows the motor and maintains the set level of vacuum

C VACUUM PUMP

Industrial quality. Oil-cooled vacuum pump. These pumps include a wide range of accessories making them safe and efficient. Programmable start/stop. Remote control (cellular or computer). Vacuum adjustment based on temperature, fully automated. Electric engine from 1.5 hp up to 20 hp
 Available with Honda gas or diesel motor (*NOT SHOWN*)
 Oiler (*NOT SHOWN*)

D Moisture traps 1 1/2", 2" or 3"

361944	10" x 24" Moisture trap & 1.5" inlet
363597	10" x 24" Moisture trap & 2" inlet
361975	15" x 30" Moisture trap & 2" inlet
363177	15" x 30" Moisture trap with pen switch & 3" inlet
363146	15" x 30" Moisture trap with pen switch & 2" inlet
362330	15" x 30" Moisture trap & 3" inlet
363627	10" x 24" Moisture trap with pen switch & 2" inlet

Other moisture traps size available

E "Flood" oil reclaimer
 The FLOOD oil reclaimer lets vacuum pumps operate up to 27 Hg.

F COOLING UNIT FOR "FLOOD" OIL RECLAIMER

Cooling unit lets vacuum pumps operate up to 27 Hg
 This system necessarily operates with the "FLOOD" oil recuperator
 The majority of oil injected into the pump is reclaimed by the "FLOOD" oil reclaimer and the cooling unit will cool down before it returns to the pump.
 Temperature control controls the radiator fan according to the oil temperature.
 This system works with all oil and water-recirculation vacuum pumps
 Fits all cold oil model pumps (De Laval, Universal, Elmira)
 Injects 2 litres of oil/minute to cool pump for maximum efficiency



D&G VACUUM CLAW PUMP



Designed specifically for the maple syrup industry, this pump features an integrated condensate drain and delivers powerful vacuum performance, reaching up to 28.4 Hg.

Available in 230v and 575v, tri-phase

Model	HP	M ³ Displacement
DG100	4	100
DG180	5	180
DG250	7.5	250
DG360	10	360



VACUUM PUMPS

A



B



C



A VACUUM PUMP AND DRIVE FOR 800 TO 12,500 TAPS

Compact oil pump for tight spaces. Available in many sizes.

Vacuum over 29 Hg

May operate with hydraulic vegetable oil

230 volts (available on 3 PH voltage)

INCLUDES:

Vane pump

Flood - Oil collector

Speed modulating drive

Vacuum probe with display

Radiator

Check-valve

Digital thermostat

Ball valve

Damp trap with level controller

Couplings and fittings

(accessories can be modified on request)

Stand (optional)

MINI VACUUM PUMP

For sugar bushes of 800 taps and less. 8 CFM 27 Hg vacuum pump.

Magnetic starter (thermostat not included).

Flood Oil collector (temperature indicator not included).

Damp trap.

Vacuum control.

Oil level gauge.

Check valve (sap releaser not included).

Approved system CSA.

- B 377839** D&G Vacuum pump 151 flood 3 hp Kit
- 363511** Gas Honda motor 5.5 hp with electric starter
- C 378096** $\frac{3}{4}$ hp electric motor with radiator and thermostat
- 378041** Gas Honda motor 5.5 hp with electric starter and radiator
- 378072** Gas Honda motor 5.5 hp with manual starter and radiator
- 371431** 8 CFM 1750 vacuum pump head

ECO-FRIENDLY OIL FOR VACUUM PUMPS (NOT SHOWN)

- 361852** 3.7 L Regular vacuum pump oil
- 363955** 3.7 L "Flood" vacuum pump oil
- 361883** 18.9 L Regular vacuum pump oil
- 364167** 18.9 L "Flood" vacuum pump oil
- 372162** 18.9 L Radiator oil pump
- 364815** High performance flood filter

VACUUM PUMPS WITH GUZZLER DIAPHRAGM

Economic models for small operations.

500 taps and less until 25" Hg

A 386572 Diaphragm vacuum pump, 115 volts

1,000 taps and less

B 386596 Double diaphragm vacuum pump, 115 volts

VACUUM REGULATORS

C 401473 Small pressure regulator (DG 312-1)

D 401374 Medium regulator

E 362187 Adjustable vacuum control

F 374685 3/4" copper vacuum control with spring

407772 1" PVC vacuum control with spring

G AUTOMATIC VACUUM CONTROL

408427 Automatic vacuum control

Electric vacuum control, wireless remote monitoring and control for pump station

3.5" colour touch panel screen (HMI)

Can manage master lines and be accessed by phone, tablet or computer.

H PRESSURE WASHER

Cold water pressure washer

Pressure: 5000 psi

Flow: 5.0 gpm

TS119 1450RPM industrial pump

motor 20hp TEFC 230VOLT 3 phase
(also available on 460 and 575 3 phase)

50' Hose

MANY MORE MODELS AVAILABLE

I ANTI-WATER BALL BASKET

435423 Basket 2" PVC waterproof ball

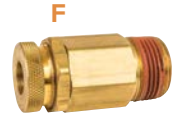
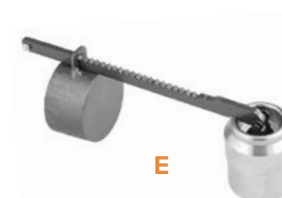
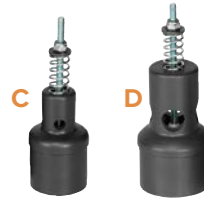

TOTAL AUTONOMY

Have absolute control over your data

Reinvent your surveillance: our product combines internet connectivity and intranet autonomy. Control your data without fees or third parties.

VACUUM MONITORING

122033 D&G REMOTE MONITORING STARTER KIT (INCLUDES A, B AND C)



A 121258
D&G SERVER (SOFTWARE)

Mandatory for all setups
At the heart of D&G's monitoring system



B 122224
WIRELESS GATEWAY

Sends information collected by the wireless sensors to the D&G server



C 122231
MOBILE GATEWAY

Link between a smartphone and the wireless sensors



D 122200
SINGLE VACUUM WIRELESS SENSOR

Vacuum and temperature readings for **1** mainline



E 122217
DOUBLE VACUUM WIRELESS SENSOR

Vacuum and temperature readings for **2** mainlines



122248
WIRELESS TANK LEVEL SENSOR

Monitoring of sap levels in a tank up to 25 feet high



119573
MODULATING VALVE FOR VACUUM PUMP

Makes it possible to lower the vacuum of the pumps without modifications to them



121326
INPUT-OUTPUT CONTROL BOX

Controls and monitors pumping stations. Required for vacuum pump modulation



SURVEILLANCE CAMERAS

121142 Rotary camera
121234 Fixed camera

MAPPING SERVICES

LARGE FORMAT MAP OF YOUR SUGAR BUSH

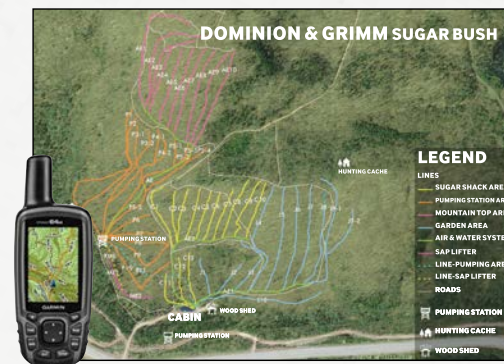

SUGAR BUSH MAPPING SERVICES

- GPS mapping of your site
- Tubing layout designed by an experienced team
- Tubing system installation according to your terrain and criteria (transfer tanks, wet/dry system, etc.)
- Precise evaluation of the material required
- Accurate plan of your tubing system, stations, buildings, etc.
- Map printing, after completion of your project

COROPLAST PRINTING SIZES:
2' X 3' 3' X 5' 4' X 8'

4TH GENERATION MONITORING & CONTROL

NO MONTHLY FEES OR INTERNET ACCESS REQUIRED. BETTER REACH, QUICKER INSTALLATION, SHORTER RESPONSE TIME.

The latest generation of our powerful software for monitoring and complete surveillance of your Sugar bush on a tablet, computer or cell phone. The system allows for an overview of all your sensors and pumping stations to effectively optimize the performance of your sugar bush. Unlike our competitors, all of this is possible without requiring an internet connection.



FEATURES

- Mapping of your Sugar bush
- Vacuum and leak detection sensors on each mainline with leakage and equipment malfunction warnings
- Remotely control your equipment (Vacuum pumps, sap pumps, pipe drainage, releasers and others)
- Increased sensors' battery life with a new off-season mode. Facilitates system restart at the beginning of each season.
- Metering of sap tank levels
- History of vacuum vs temperature data
- Freeze reports
- Releaser water metering system
- Integrated camera system
- Compatible with previous version



LEARN MORE



ECONO SERIES

MAIN PLUMBING
MADE OF
STAINLESS STEEL

14 new models of R/O, 400 to 3000 GPH

Sequential pump start

Digital Temperature indicator

Each membrane has its own flow-meter and sampler.

ECONO SERIES

For 1000 - 20,00 taps.

Complete and easy to operate

Stainless steel frame

Wash tank

Flow meter

Dial thermometer

Automatic shutoff when sap tank is empty

Instruction panel with pictograms

Set of 3-way valves for installation

Stainless steel casings for membranes

Starting at 400 gallons/hour

Econo model available up to 20 000 taps

1 600 GALLONS



400+ GALLONS ECONO

NOTE

PERFORMANCE
CALCULATIONS
ARE BASED ON
SAP AT 55°F,
CONCENTRATED
FROM 2 - 8 BRX

LX SERIES

LX-B
LX-PLATINUM



AUTOMATION
AVAILABLE

**HORIZONTAL
VERSION**
AVAILABLE
WITH LARGER
PIPES 1.5"



LX-1600 MODEL

LX SERIES

For 1000 to 20 000 taps.

Simplified timer 0 - 60 minutes

High temperature indicator light

Pump motor overload warning light

The filtrate, concentrate and drain outlets are equipped with NTP adapters

An air purge tank is installed on each model

The 600 and more models are equipped with a 3-cartridge RAM filter except for the 3000 and 3000-B2 models which

have a 7-cartridge RAM filter.

Complete and easy to operate

Stainless steel frame

Wash tank

Flow meter

Automatic shutoff when sap tank is empty

Instruction panel with pictograms

Set of 3-way valves for installation

Stainless steel casings for membranes

MOUNTAIN 2.0



AUTOMATION
AVAILABLE

- 3 x 10 hp feed pumps with variable speed "drive" starter
- 6 x 10 hp pressure pumps with variable speed "drive" starter
- 6 recirculation pumps 5 hp
- 3 cylinders 8' x 80"
- 3 recirculation pumps 3 hp
- 6 filters with 7 cartridges per filter
- 4 recirculating pumps 2 hp
- TDS reader (conductivity of permeate)
- Brix reader 0 - 33 Brix
- Concentrate to 25 Brix and more
- Entirely made of 304 stainless steel
- *Specs and features are for the pictured model

38 MEMBRANES

The mountain model is available with 3, 4, 6, or 8 pumps.

Up to 18 000 gallons per hour

Contact your rep for more information

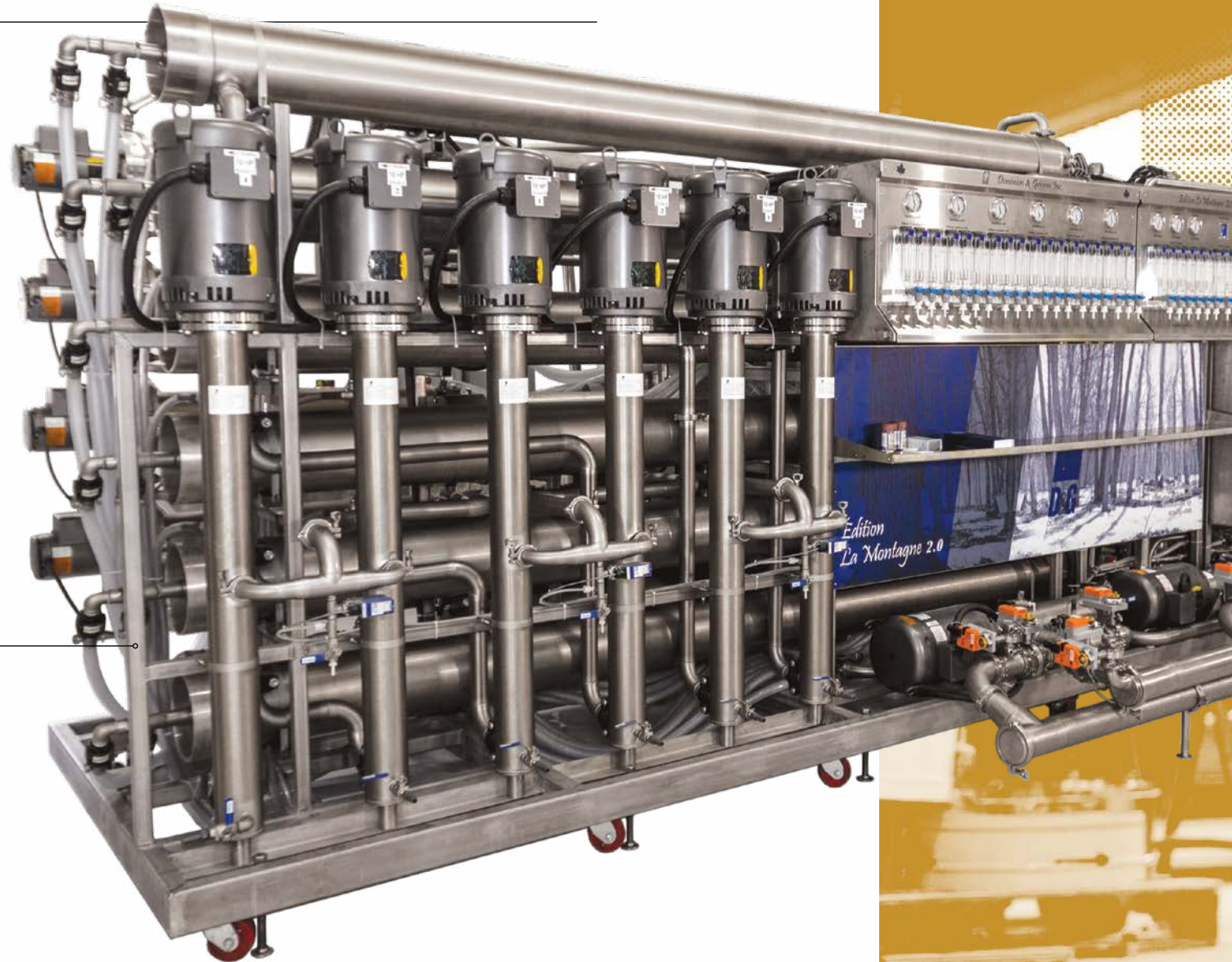

BRIX CHART FOR REVERSE OSMOSIS

Reduce boiling time by removing water with reverse osmosis

° BRIX	% WATER REMOVED	SAP REQUIRED TO PRODUCE ONE GALLON OF SYRUP
2	0	43
8	75%	10.75
10	80%	8.6
15	87%	5.7
20	90%	4.3
25	92%	3.44
30	93.3%	2.86
35	94%	2.45

RAM EDITION

FULL AUTOMATED "PRESTIGE"
R/O RAM EDITION WITH 1000
GALLONS HIGH BRIX

FULL AUTOMATIC 400 GPH / 1600 GPH R/O

400 GPH or 1600 GPH models

High Brix R/O (over 20 Brix)

Full automatic model

Daily schedule programmable to save labour

No labour required after R/O started

10 choices sequences to program the automate

Remote start (option)

The full automatic R/O can manage your tank
by mobile, tablet,
or computer (option)

Automatic soap injection

Multi-stage pump 7.5 hp stainless steel

Recirculation pump 3 hp stainless steel

3 stainless steel RAM filter cartridges



AUTOMATION
AVAILABLE

AUTOMATED CONTROL OF BRIX DEGREE

D&G are pioneers in the field of osmosis
automation with more than 10 years
of experience.



PRESTIGE EDITION

THE ONLY TRULY
AUTOMATED & FLEXIBLE
REVERSE OSMOSIS

LEARN MORE

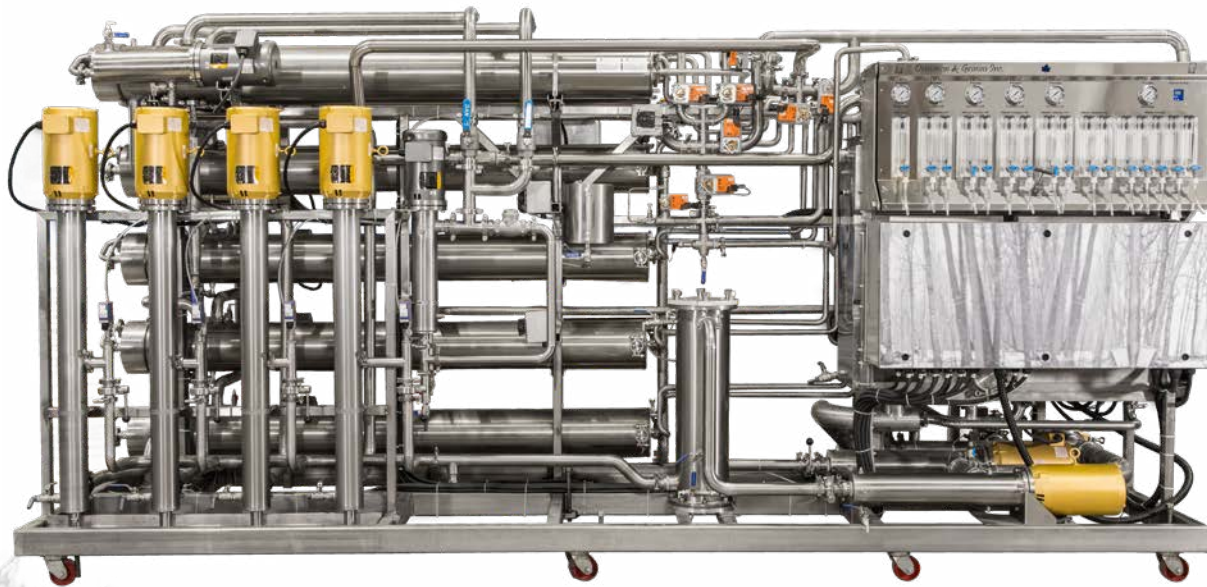

4 Stainless steel housings for 3 membranes, 8" x 80"
4 Stainless steel housings for 1 membrane, 8" x 40"
4 High-pressure pumps in stainless steel, 7.5 hp
Feed pump in stainless steel, 7.5 hp
Most efficient on the market (150 Amps / 220 Volts)

FULLY AUTOMATED PRESTIGE PLATINUM

Programmable cycle sequence. 10 different programmable and flexible sequences each comprising 14 cycles.
Stop, start and arrangement of cycles according to the conditions set by the operator
Model with high concentration (20 Brix and more) available
User-friendly and intuitive Schneider touchscreen on mobile console.
Autonomous, no connection to external servers required

Remote access to all device functions and controls (PLC)
Platinum model available with 1 to 28 membranes
All impellers are made of stainless steel
Stainless steel vessels
Stainless steel plumbing
All electrical and automation components are from Schneider
Available in 3 models:
1 Full automatic Platinum
2 Standard



SCHNEIDER 15" TOUCHSCREEN ON MOBILE CONSOLE FOR THE PRESTIGE MODEL

SCHNEIDER TOUCHSCREEN INTERFACE

D&G R/O systems with touchscreen control: advanced technology

Choose the selected mode on the screen and the machine will start in that mode

Schedule 1 day without adjusting or making changes to the manual cycle

Requires no labour after it is started



OSMOSIS

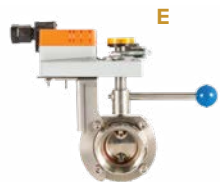

SPORTSMAN 80 - 160 GPH

Ideal to cut in half your volume of maple water to evaporate. For 800 taps and less.

295003 Sportsman 80 GPH
1 membrane (4"), 1 Fluid-o-Tech pump

A 295591 Sportsman 100 GPH
–1 membrane 4", 1/2 HP priming pump & Grundfos pressure pump
–Can be upgraded by adding a second membrane.

B 294969 Sportsman 160 GPH
2 membranes (4"), 1/2 HP priming pump & Grundfos pressure pump

C BRIX CONTROL MODULE FOR OSMOSIS

295126 The Brix controller for osmosis allows you to manage the Brix concentration of your osmosis. Making it possible to maintain a constant Brix level.

Suitable for all conventional osmosis regardless of the brand

Continuous reading of the sugar level with permanent display

Allows high data accuracy and time savings

No manual sampling required

Can be managed remotely with a smartphone, computer or tablet (option)

Suitable for all brands of conventional osmosis

Schneider PLC

D ATAGO REFRACTOMETER 0-33 BRUX

126543 Atago refractometer - CM-BASE (A) - 0 - 33 Brix

E AUTOMATED VALVES FOR TANK

Full automatic R/O can manage your sap tank and permeate tank

The computer manages the electric valves of your tank with sap level detector

Butterfly valves of 1.5" to 4"

F EXPANSION KIT FOR R/O

292071 Econo Expansion kit with 1.5 hp recirculation pump.
Also available with 3 hp recirculation pump.

OSMOSIS ACCESORIES

SEDIMENT STRAINER

- A 131356** Y shaped 2" sediment strainer
 - B 131370** Y shaped 4" sediment strainer
- Entirely made of stainless steel
1.5", 2", 3" and 4" adapters available

STORAGE HOUSING FOR MEMBRANES

- C 359965** Storage housing for 8" x 40" membrane
- D 360480** Storage housing for 4" x 40" membrane

E MAPLE SAP FILTER CARTRIDGES

SPECIAL PRICE (FULL CASE)

- 485077** 2 x 10, Purtrex 5 microns (box of 40)
- 485091** 2 x 20, Purtrex 5 microns (box of 20)
- 485138** 2 x 20, Purtrex 10 microns (box of 20)
- 485121** 2 x 20, Purtrex 75 microns (box of 20)
- 367465** Cartridge union 2" for sap
- 367311** Gasket for 2 X 20 cartridge case

F BAGS FOR SAP FILTER - 50 - 100 MICRONS

- 487651** 8" x 17", 50 microns\$9.50
- 487613** 8" x 30", 50 microns.....\$14.50
- 487774** With rope 8" x 17", 25 microns.....\$9.50
- 487798** With rope 8" x 30", 25 microns\$14.50

- G 487637** Bag holder\$45.10

H SS FILTER FOR MULTIPLE CARTRIDGE

- 134241** RAM filter (3 cartridges)
- 292262** 5200 filter (7 cartridges)

MEMBRANES HYDRANAUTICS, ESPA4-LD

- I 485237** 4" x 40" Membrane
- 360404** 8" x 40" Membrane

CLEANING SERVICE AVAILABLE



PH NEUTRALIZATION SYSTEM

SUGAR BUSH WASTEWATER NEUTRALIZATION SYSTEM

THIS SYSTEM PROVIDES RELIABLE, FLEXIBLE, AND POWERFUL CONTROL FOR THE TREATMENT OF WASTEWATER DISCHARGED FROM REVERSE OSMOSIS. NO MATTER THE MANUFACTURER OR THE MODEL.

Allows the neutralization of washing water pH before its release into the environment.

Smart control box with easy-to-use touchscreen

Remote management and real-time data consultation

Data recording of all sensors allowing the creation of tables and graphs.

Transferable to USB key. Useful for providing reports required by environmental authorities.

Integrated management on automated D&G Osmosis (Platinum)

Piping entirely in stainless steel

Completely autonomous



PH NEUTRALIZATION
SYSTEM



WATCH DEMO



REVERSE
OSMOSIS
MODE

WASTEWATER
WASH MODE

PERMEATE DRAIN



TO SEWAG FIELD PH IS
NEUTRALIZED



PH READING AND
RECIRCULATION

PH-

PH+

NEUTRALIZER
INJECTION

AGITATOR

RETENTION
TANK

MAINLINE (FOOD GRADE)



A BLUE MAINLINE FOOD GRADE APPROVED

458484	100 lb 1/2", 500	479731	100 lb 1 1/4", 500'
479717	100 lb 3/4", 500'	456541	100 lb 1 1/4", 1000' *
455674	100 lb 3/4", 2500' *	479748	100 lb 1 1/2", 250'
479724	120 lb 1", 500'	456947	100 lb 1 1/2", 900' *
455698	120 lb 1", 2000' *	457005	100 lb 2", 500'

* On Spool

B BLACK MAINLINE TUBING FOOD GRADE APPROVED

455711	100 lb 1/2", 500	479779	100 lb 1 1/4", 300'
479755	100 lb 3/4", 500'	455834	100 lb 1 1/4", 1000' *
455759	100 lb 3/4", 2500' *	479786	100 lb 1 1/2", 250'
479762	120 lb 1", 500'	455872	100 lb 1 1/2", 900' *
455797	120 lb 1", 2000' *	455919	100 lb 2", 500'

* On Spool

C LASHED TUBING FOOD GRADE APPROVED

	BLACK		BLUE
456121	100 lb 3/4", 2500'	454936	100 lb 1", 2000'
456145	120 lb 1", 2000'	454950	120 lb 1 1/4", 1000'
456169	100 lb 1 1/4", 1000'	454745	100 lb 1 1/2", 900'
468995	100 lb 1 1/2", 900'		

D TENSION GRIPS FOR MAINLINE

104893	1" tension grip
104909	1 1/4" tension grip
104916	1 1/2" tension grip
104923	2" tension grip

BASE FOR PICKETS

F 023323	Picke base (round) 2" x 2"
023316	Hybrid 2 x 3

G FOAM FOR MAINLINE

E CEDAR PICKETS

023361	2 x 2, 6' (packs of 9)
023378	2 x 2, 8' (packs of 9)

480102	1" foam (24/pack)
480249	1 1/4" foam (12/pack)
480164	1 1/2" foam (12/pack)
480188	2" foam (10/pack)

OTHER LENGTHS AVAILABLE UPON REQUEST

FUSION TUBING

Process to combine tubes and fittings
Fusion bonding of endings

ADVANTAGES

Eliminates leaks and protects tubing by creating a shell against the weather
Increased output and performance
Saves time and money on labour

8 EASY ELECTROFUSION STEPS

After flattening them, align the ends of the tubes
Set the welding by adjusting the heat
Melt the material by joining the ends
Prepare the tubing surface for better adhesion of the fusion and electrofusion fittings
Screw the saddle on the tube (B)
Insert the coupler on the saddle (C)
Activate fusion using the scanner (D)
Let the fusion cool down

A HIGH DENSITY BLACK POLYETHYLENE MAINLINE TUBING (ELECTROFUSION)

467691	1" black, 500'	467585	2" black, 2000**
469008	1 ¼" black, 500'	467592	3" black, 800**
469015	1 ¼" black, 4000**	469053	1 ½" blue, 500'
466403	1 ½" black, 500'	469060	1 ½" blue, 3500**
467561	1 ½" black, 3500**	469077	2" blue, 500'
466410	2", 500'	469084	2" blue, 2000**

FITTINGS FOR MAINLINE (ELECTROFUSION)

B SADDLES	C COUPLERS
467752 1 ½" X 1"	467721 1"
467769 2" X 1"	467738 1 ½"
	467745 2"

OTHER SIZES AND FITTINGS AVAILABLE

TUBING



FUSION

All your polyethylene tubing is fusible with all types of fittings on the market



WATCH DEMO



ELECTROFUSION UNIT PURCHASE OR LOCATION



IPEX

TUBING

NO COMPROMISING ON QUALITY
SAME RESIN SINCE 1998



5/16" TUBING



3/16" TUBING



5/16" HW TUBING



ALL OUR TUBINGS ARE
COVERED WITH A LIMITED
15 YEAR WARRANTY

DROP LINE
PRE-ASSEMBLED
AVAILABLE ON
REQUEST

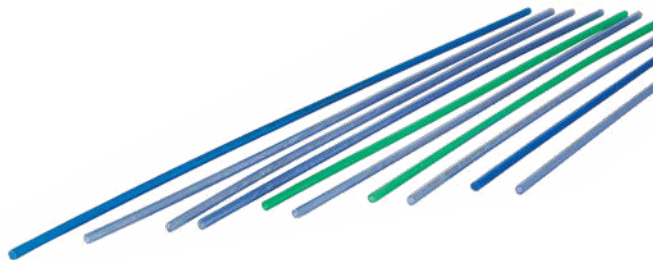

DOMINION & GRIMM 5/16" TUBING

- 459627** Semi-stiff tubing 55X, RL 500', transparent blue
- 456480** Semi-stiff tubing 75X, RL 500', transparent blue
- 456442** Semi-stiff tubing 80X, RL 500', blue
- 458668** Semi-stiff tubing 85X, RL 500', transparent blue
- 459108** Semi-stiff tubing 86X, RL, 500', light green
- 469145** Semi-stiff tubing 88X, RL, 500', grey



5/16" SEMI-STIFF TUBING (THICK WALL), HW

- 469176** Semi-stiff tubing 88X HW, RL 500' grey
- 467677** Semi-stiff tubing 86X HW, RL 500', light green
- 454929** Semi-stiff tubing 85X HW, RL 500', transparent blue
- 454912** Semi-stiff tubing 83X HW, RL 500', transparent blue
- 466502** Semi-stiff tubing 70X HW, RL 500', transparent blue

3/16" SEMI-STUFF TUBING

- 454844** Semi-stiff tubing 31 X 3/16", RL 500', blue
- 454783** Semi-stiff tubing 32 X 3/16", RL 500', light green

OTHER COLOURS AND CATEGORIES OF
TUBING AVAILABLE ON REQUEST

DOMINION & GRIMM PRE-CUT DROP LINES

COLOUR		32"	36"	40"
REGULAR		5/16" TUBING		
Transparent blue	75x		458781	462603
Transparent blue	85x		458774	462641
Transparent green	86x		461392	
HEAVY WALL		5/16" TUBING		
Transparent blue	75x HW	467653	466441	
Transparent blue	85x HW		466526	
Transparent green	86x HW		454646	
REGULAR		3/16" TUBING		
Duraflex blue			467530	
Duraflex green			467547	

OTHER DROP LINES CATEGORIES AND LENGTHS
AVAILABLE ON REQUEST. MINIMUM QUANTITY OF 10,500



- 474200** 7/16" short spout, blue
- 474316** 7/16" short spout, black

TUBING FITTINGS D&G WML FITTINGS (WITHOUT MICRO LEAKS)



- 511387** 5/16" spout, blue
- 511356** 5/16" spout, black
- 511363** 5/16" spout, white
- 511851** 5/16" spout, flexible nylon, gray



- 474255** 5/16" spout, blue
- 508882** 3/16" - 5/16" spout, blue
- 474279** 5/16" spout, black
- 508899** 3/16" - 5/16" spout, black
- 474262** 7/16" spout, black
- 510397** 5/16" spout, white



- 510304** 5/16" 110° nylon spout, blue
- 476266** 5/16" 110° nylon spout, black
- 510380** 5/16" 110° nylon spout, white



- 508806** 5/16" - 1/4" spout, blue
- 508844** 3/16" - 1/4" spout, blue
- 508813** 5/16" - 1/4" spout, black
- 508851** 3/16" - 1/4" spout, black
- 508837** 5/16" - 1/4" spout, white

TUBING FITTINGS

D&G WML FITTINGS
(WITHOUT MICRO LEAKS)

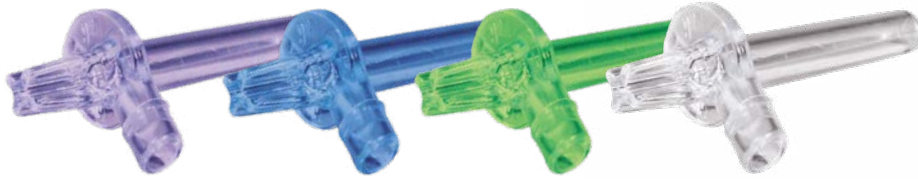

- 479267** 5/16" 110° disposable polycarbonate spout, purple
- 511868** 1/4" 110° disposable polycarbonate spout, purple
- 510366** 5/16" 110° disposable polycarbonate spout, blue
- 511875** 1/4" 110° disposable polycarbonate spout, blue
- 479489** 5/16" 110° disposable polycarbonate spout, green
- 511882** 1/4" 110° disposable polycarbonate spout, green
- 479250** 5/16" 110° disposable polycarbonate spout, clear
- 479236** 1/4" 110° disposable polycarbonate spout, clear

THIN
WALL

POLYCARBONATE SPOUTS



- 508820** Chalumeau jetable 5/16" à 1/4", clair
- 465932** Chalumeau jetable 5/16", clair
- 509056** Chalumeau jetable 3/16", clair



- 511820** 5/16" - 5/16" spout, pink
- 511387** 5/16" - 1/4" spout, pink

FOR EACH SPOUT SOLD, D&G
WILL GIVE BACK \$0.01 TO THE



REDUCERS & ADAPTERS

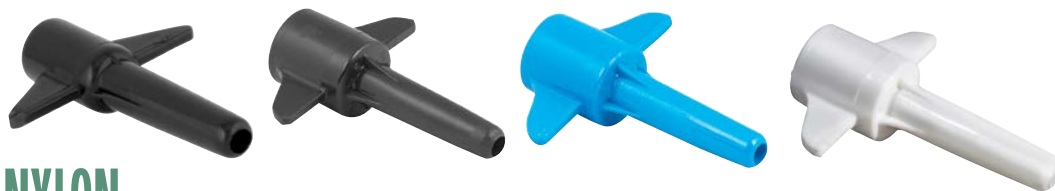

NYLON

- 474439** Reducer 7/16" to 1/4", black
- 465628** Adapter 5/16" to 5/16", black
- 465697** Adapter 5/16" to 5/16", blue
- 474286** Spout reducer 7/16" to 5/16", blue
- 510403** Spout reducer 7/16" to 5/16", white
- 474408** Spout reducer 7/16" to 5/16", black



POLYCARBONATE

- 511783** Reducer 5/16" à 1/4", clair
- 465703** Adapter 5/16" à 5/16", clair
- 465604** Reducer 7/16" à 5/16" disposable, polycarbonate, clair
- 510724** Reducer 7/16" à 1/4" disposable, polycarbonate, clair



- 511790** 5/16" long T-plug, blue
- 510649** 5/16" long T-plug, black
- 508905** 3/16" long T-plug, black
- 510441** 5/16" - 5/16" - 3/16" long T-plug, black



- 511349** 5/16" universal T-plug with enlarged gas chamber, black
- 511325** 5/16" blocked on left long T-plug, green
- 511332** 5/16" blocked on right long T-plug, green
- 479205** 3/16" blocked on left long T-plug, green
- 479212** 3/16" blocked on right long T-plug, green
- 510601** 3/16" - 3/16" blocked long T-plug, green

5/16" - 3/16" T-PLUGS



- 510656** 5/16" universal T-plug, black
- 508929** 3/16" universal T-plug, black
- 510809** 3/16" - 3/16" - 5/16" T-plug, black
- 510670** 5/16" short female T-plug, black

D&G SMF MANIFOLDS

EXCEPTIONAL SEALS



- 510861** Manifold D&G 5/16" (not assembled)
Includes:
- 389764** Manifold, D&G 5/16" fixed head
- 510847** Manifold joint 3-16" or 5/16" WML
- 510960** Hose clamp 1" and screw. 31/64" drilling



- 468735** Manifold D&G 5/16" (not assembled)
Includes:
- 389764** Manifold, D&G 5/16" fixed head
- 510847** Manifold joint 3-16" or 5/16" WML
- 511844** Hose clamp 1 1/4" and screw. 31/64" drilling



- 510854** Manifold D&G 3/16" (not assembled)
Includes:
- 389795** Manifold, D&G 3/16" fixed head
- 510847** Manifold joint 3-16" or 5/16" WML
- 510960** Hose clamp 1" and screw. 31/64" drilling

TUBING FITTINGS

D&G WML FITTINGS
(WITHOUT MICRO LEAKS)

END OF LINE ELBOW HOOKS

UNIONS



- 510786** 5/16" union with eyelet, black
- 510779** 5/16" union with hook, black
- 510793** 5/16" union, black
- 465321** 3/16" union with hook, black
- 510908** 5/16" - 3/16" union reducer with hook, black



- 510977** 5/16" end of line elbow hook, black
- 510663** 5/16" long elbow hook, black
- 479120** 3/16" long elbow hook, black
- 479113** 3/16" end of line elbow hook, black

MISC



- 510328** 5/16" antibacterial reservoir for alcohol sterilization



- 509032** 5/16" 2SP end of line elbow hook, black
- 509049** 3/16" 2SP end of line elbow hook, black



- 510151** 5/16" 6-way star fitting, black
- 510144** 5/16" 3-way star fitting, black



- 465918** 5/16" fork, black



- 463495** 5/16" "Y", black



- 465987** 5/16" loop with pin, black

SPOUTS



- 476136** 5/16" straight disposable spout, clear
- 474170** 5/16" spout, black



SLIDING FITTINGS



- 006579** Sliding hook fitting
- 006609** 5/16" sliding coupler
- 006623** 3/16" WML sliding fitting



TOMAHAWK



- 501197** 5/16" Tomahawk spout, clear
- 510830** 5/16" Tomahawk spout, transparent blue
- 510984** 5/16" Tomahawk spout, transparent green



PLASTIC MANIFOLD



- 463693** 3/4" single manifold kit
- 463716** 1" single manifold kit
- 463730** 1 1/4" single manifold kit
- 510199** 5/16" saddle, black
- 510168** 3/4" saddle, black



ADAPTORS



- 510717** 5/16" - 5/16" polycarbonate adaptor, clear
- 510700** 5/16" - 5/16" polycarbonate adaptor, transparent blue



CAPS & T-PLUGS



- 500763** 5/16" cap



MANIFOLDS

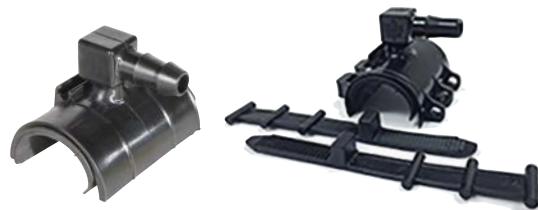

- 476235** 5/16" manifold with fixed head - 31/64" drilling, black
- 465758** 3/16" manifold with fixed head - 31/64" drilling, black
- 463600** 31-64" WML fixed head manifold kit
- 465970** Fastener for universal manifold



DU-EAU SPOUTS



- 510359** 19/64" Du-Eau spout, blue
- 474156** 19/64" Du-Eau spout, black
- 510694** 1/4" Du-Eau spout, black
- 510885** 1/4" Du-Eau spout, blue

WIRES & VALVES

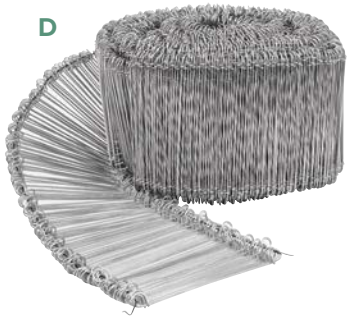
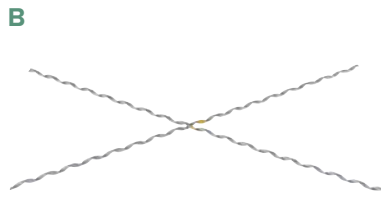

A GALVANIZED WIRE, QUALITY N° 1

480003 N° 8, 65 lb, 1000' high density

480379 N° 9, 50 lb, 900'

480355 N° 12, 50 lb, 1735'

480256 N° 14, 50 lb, 2900'

480324 N° 10, 50 lb, 1100' approx. high density5

B SPLICES

466151 Set of 2 for #8 wire, Orange

466205 Set of 2 for #8 wire, White

466168 Set of 2 for #10 wire, Black

C STAINLESS STEEL BALL VALVES

044663 1/2"

044694 3/4"

044724 1"

044755 1 1/4"

044786 1 1/2"

044816 2"

D GALVANIZED 16GA TWISTING CLIPS, ROLL OF 2500

479977 10", 2" mainline

GALVANIZED 18GA TWISTING CLIPS, ROLL OF 2500

480348 4", 1/2" mainline

480133 5", 3/4" mainline

480157 6", 1" mainline

480171 7", 1 1/4" mainline

480195 8", 1 1/2" mainline

480218 10", 2" mainline

480225 12", 3" mainline

480232 14", 3" mainline

TWISTERS

E 475078 Hand twister

F 475115 Red automatic twister

479496 Heavy-duty automatic twister

LARGE GRIPPLE-JOINER - NO° 6, 9, 12 AND 14 GAUGE **GRIPPLE**

Maximum sustained load: 1200 lb

G 480430 Tensioning tool for gripples

H 466267 More large gripple (10 - 7.5 gauges)

STAINLESS STEEL FITTINGS

STAINLESS STEEL FITTING SELECTION N°304
(SS) OTHER SIZES AVAILABLE IN STORE



SHORT UNIONS

	L"	INS"
466533	2-3/4"	1/2"
465031	2-3/4"	3/4"
464850	2-3/4"	1"
464911	2-3/4"	1-1/4"
464874	2-3/4"	1-1/2"
464973	2-3/4"	2"



CLAMPS TRIDON

REGULAR	SIZE
104343	3/4"
104374	1"
104404	1-1/4"
104435	1-1/2"
104466	2"



CLAMPS

REGULAR	SIZE	STAINLESS STEEL
	3/4"	511196
511080	1"	511226
	1-1/4"	511257
	1-1/2"	511288
	2"	511318



LONG UNIONS

	L"	INS"
465055	4"	3/4"
464959	4"	1"
464935	4"	1-1/4"
464898	4"	1-1/2"
465017	4"	2"
465086	5"	3/4"
466540	5"	1"
464942	6"	1/4"
464980	6"	2"



CLAMPS

STAINLESS STEEL	SIZE
104527	3/4"
104589	1"
104640	1-1/4"
104701	1-1/2"
104763	2"



BREEZE CLAMPS

ROBUST	SIZE
104855	1"
104862	1-1/4"
104879	1-1/2"
104886	2"



ADAPTATEURS

	INS"	MIPT"
466892	1/2"	1/2"
466939	1/2"	3/4"
466915	3/4"	1/2"
466953	3/4"	3/4"
466977	1"	3/4"
467011	1"	1"
467059	1"	1-1/4"
467110	1"	1-1/2"
467035	1-1/4"	1"
467134	1-1/4"	1-1/2"
467097	1-1/2"	1-1/4"
467158	1-1/2"	1-1/2"
467196	1-1/2"	2"
467172	2"	1-1/2"
467219	2"	2"



QUICK CONNECT WITH FERRULE

	INS"
480881	3/4"
480805	1"
480898	1-1/4"
476846	1-1/2"
476877	2"



REDUCERS

	INS B"	INS A"
464799	3/4"	1"
464775	3/4"	1-1/4"
464737	3/4"	1-1/2"
464751	1"	1-1/4"
464829	1"	1-1/2"
466878	1"	2"
464713	1-1/4"	1-1/2"
464836	1-1/4"	2"
464812	1-1/2"	2"
481390	2"	3"



"Y"

	INS B"	INS A"
466595	3/4"	1-1/4"
466632	1"	1"
466694	1-1/4"	1-1/4"
466779	1-1/2"	1-1/2"
466854	2"	2"



"T"

	INS A"	INS B"	INS C"
050039	3/4"	3/4"	3/4"
466089	1"	1"	3/4"
466786	1-1/4"	1-1/4"	1"
050022	1-1/4"	1-1/4"	1-1/4"
466687	1-1/2"	1-1/2"	1"
050046	1-1/2"	1-1/2"	1-1/2"
050060	2"	2"	2"

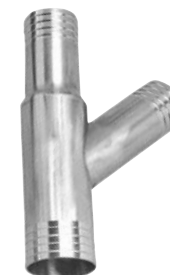

"Y" REDUCERS

	INS A"	INS B"	INS C"
466601	1"	3/4"	3/4"
466656	1 1/4"	1"	3/4"
466625	1-1/4"	1"	1"
464843	1-1/2"	1"	1"
481123	1-1/2"	1-1/4"	1-1/2"
481536	2"	1-1/2"	1-1/4"

STAINLESS STEEL FITTINGS & PLUMBING



COUPLINGS NPT

048869	1/2"
048876	3/4"
048883	1"
048890	1-1/4"
048920	1-1/2"
048951	2"



"T" FIPT

049798	1/2"
049828	3/4"
049859	1"
049880	1-1/4"
049910	1-1/2"



CAPS MIPT

050787	1/2"
050817	3/4"
050848	1"
050879	1-1/4"
050909	1-1/2"
050930	2"



ELBOWS FIPT X FIPT

045806	1/2"
045837	3/4"
045868	1"
045899	1-1/4"
045929	1-1/2"
045950	2"



UNIONS FNTP

050305	1/2"
050336	3/4"
050367	1"
050398	1-1/4"
050381	1-1/2"
050428	2"



ELBOWS 90° MIPT X FIPT

048869	1/2"
048876	3/4"
048883	1"
048890	1-1/4"
048920	1-1/2"
048951	2"



ADAPTORS INS X MIPT

064159	1/4"	1/4"
064142	3/8"	3/8"
051685	1/2"	1/2"
051715	3/4"	3/4"
064135	1"	1"



REDUCERS MIPT X FIPT

051371	3/4"	3/8"
051296	3/4"	1/2"
051333	1"	1/2"
051326	1"	3/4"
051388	1-1/4"	1"
047770	1-1/2"	1-1/4"



TEFLON TAPE FOR SS FITTINGS

157622	Teflon sealing tape 1/2" SS, gray
157615	1/2" Teflon sealing tape, white

NIPPLES NPT



047138	1/4" x close
047145	3/8" x close
047152	1/2" x close
047183	1/2" x 2"
047213	1/2" x 2-1/2"
047244	3/4" x close
047275	3/4" x 2"
047299	3/4" x 3"
047305	3/4" x 5"
047312	3/4" x 6"

047336	1" x close
047367	1" x 2"
047428	1" x 3"
047480	1" x 5"
047435	1" x 6"
047541	1-1/4" x close
047572	1-1/4" x 2"
047633	1-1/4" x 4"
047664	1-1/4" x 5"
047695	1-1/4" x 6"
047602	1-1/4" x 2-1/2"
047794	1-1/2" x close
047817	1-1/2" x 2"
047848	1-1/2" x 2-1/2"
047909	1-1/2" x 3"
047930	2" x close
047960	2" x 3"

"O-RING" FOR ADAPTOR
(NOT SHOWN)

465192	3/4"
465215	1"
465253	1-1/2"
465277	2"



DUST CLAMPS ONLY DC, MALE ADAPTORS

461491	3/4" x 1/2"
461514	1" x 1-1/4"
461552	1-1/2"
461576	2"



FEMALE COUPLER HOSE SHANKS FOR "CS" POLYETHYLENE

462153	1/2"
462177	3/4"
462191	1"
462214	1-1/4"
462238	1-1/2"
462252	2"



FEMALE COUPLER MALE THREAD EXT. "BS"

462016	1/2"
462030	3/4"
462054	1"
462078	1-1/4"
462092	1-1/2"
462115	2"



FEMALE COUPLERS FEMALE THREAD INT. "DS"

462290	1/2"
462313	3/4"
462337	1"
462351	1-1/4"
462375	1-1/2"
462399	2"



MALE COUPLER HOSE SHANKS FOR POLYETHYLENE "E"

462436	1/2"
462450	3/4"
462474	1"
462498	1-1/4"
464720	1-1/4" male
462511	1-1/2"
462535	2"



MALE COUPLERS FEMALE THREAD INT. "A"

461873	1/2"
461897	3/4"
461910	1"
461934	1-1/2" x 1/4"
461958	1-1/2"
461972	2"



MALE COUPLERS MALE THREAD EXT. "F"

462597	3/4"
462610	1"
462634	1-1/4"
462658	1-1/2"
462672	2"



DUST PLUGS FOR FEMALE COUPLER "DP"

501029	3/4" x 1/2"
501067	1" x 1-1/4"
501104	1-1/2"
501128	2"



TYPE "A" STAINLESS STEEL QUICK COUPLERS

462948	1/2"
462962	3/4"
462986	1"



TYPE "D" STAINLESS STEEL QUICK COUPLERS

463327	1/2"
463587	3/4"
463648	1"



TYPE "CS" STAINLESS STEEL QUICK COUPLERS

463655	1/2"
463662	3/4"
463686	1"



TYPE "E" STAINLESS STEEL QUICK COUPLERS

463709	1/2"
463723	3/4"
463754	1"

"QUICKCONNECT" FITTINGS & PLUMBING

PVC FITTINGS & PLUMBING



COUPLINGS (FIPT X FIPT)

457609	1-2"
457562	3/4"
457548	1"
457487	2"



COUPLINGS (SLIP X SLIP)

456886	1-1/4" x 1"
456848	1-1/2" x 1"
458491	1-1/2" x 1-1/4"
461858	2" x 1-1/4"



FEMALE COUPLINGS (SLIP X FIPT)

461590	1-" x 1"
461613	1-1/4" x 1-1/4"
461187	1-1/2" x 1-1/4"
461637	2" x 2"
457425	3" x 3"



"T" (SLIP X SLIP)

458378	3/4" x 3/4" x 3/4"
461231	3/4" x 3/4" x 1"
463174	1" x 1" x 1"
463198	1-1/4" x 1-1/4" x 1-1/4"
463228	1-1/2" x 1-12" x 1-1/2"
460586	2" x 2" x 1"



"T" (FIPT X FIPT)

458408	1/2" x 1/2" x 1/2"
458385	3/4" x 3/4" x 3/4"
458361	1" x 1" x 1"
458347	1-1/4" x 1-1/4" x 1-1/4"
458323	1-1/2" x 1-12" x 1-1/2"
458309	2" x 2" x 2"



REDUCER BUSHINGS (MIPT X FIPT)

458859	1/2" x 3/8"
458835	1/2" x 1/4"
458910	3/4" x 1/2"
458897	3/4" x 3/8"
458958	1" x 3/8"
458972	1" x 1/2"
458996	1" x 3/4"
458934	1" x 1/4"
459030	1-1/4" x 3/4"
459054	1-1/4" x 1"
459092	1-1/2" x 3/4"
459115	1-1/2" x 1"
459139	1-1/2" x 1-1/4"
459153	2" x 1"
459177	2" x 1-1/4"
459191	2" x 1-1/2"
459238	3" x 2"

AUTRES RACCORDS
DISPONIBLES



90° ELBOWS (SLIP X SLIP)

458262	3/4"
460975	1"
460999	1-1/4"
460982	1-1/2"
461019	2"



90° ELBOWS (FIPT X FIPT)

458163	3/4"
458422	1"
458149	1-1/2"
458125	2"



ADAPTORS (MIPT X SLIP)

461361	1" x 1"
461460	1-1/4" x 1-1/4"
461286	1-1/2" x 1-1/2"
461347	2" x 2"
457326	2-1/2" x 2-1/2"
457302	3" x 3"



QUICK COUPLINGS (SLIP X SLIP)

462801	3/4"
455148	1"
461255	1-1/4"
461309	1-1/2"
461323	2"



QUICK COUPLINGS (FIPT X FIPT)

461583	3/4"
461385	1"
461408	1-1/4"
461422	1-1/2"
461446	2"



REDUCING ADAPTORS (SLIP X SLIP)

458886	1-1/4" x 1"
456848	1-1/2" x 1"
458491	1-1/2" x 1-1/4"
461858	2" x 1-1/4"



PLUGS (MIPT)

467394	1/2"
437373	3/4"
467356	1"
467332	1-1/4"
467318	1-1/2"
467295	2"



90° "STREET" ELBOWS (MIPT X SLIP)

458064	1"
458040	1-1/2"



90° "STREET" ELBOWS (MIPT X FIPT)

458002	1/2"
457982	3/4"
459207	1"
457944	1-1/4"
457920	1-1/2"



PVC GLUE

463440	118ml, clair
463501	226ml, clair
463068	8oz, clair primer



**SINGLE COUPLING
PVC VALVE (SLIP X SLIP)**

462023	3/4"
462122	1"
462184	1-1/2"
462207	2"

**SINGLE COUPLING
PVC VALVE (SCREW)**

462245	3/4"
462269	1"
462283	1-1/4"
462344	2"



**PVC VALVES
(THREAD X THREAD)**

463679	1/2"
463976	3/4"
464010	1"
464058	1-1/4"
464072	1-1/2"
464119	2"



**RIGID PVC TUBING
CLEAR 10' (\$/FOOT)**

455087	1"
455681	1-1/2"
455667	2"

**RIGID PVC TUBING
WHITE 10' (\$/FOOT)**

456275	3/4"
456459	1"
456473	1-1/4"
456466	1-1/2"
456497	2"
456565	2-1/2"



**FLEXIBLE PVC TUBING,
CLEAR (\$/FOOT)**

455094	1/2"
455131	3/4"
455179	1"
455216	1-1/4"
455254	1-1/2"
455339	2"

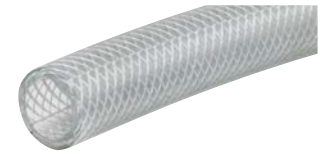

**FLEXIBLE
PVC TUBING,
REINFORCED,
CLEAR (\$/FOOT)**

455117	1/2"
455155	3/4"
455193	1"
455230	1-1/4"
455278	1-1/2"
455315	2"



**SLIP X SLIP
VALVES**

464065	3/4"
463990	1"
464034	1-1/4"
464027	1-1/2"
464096	2"



**FLEXIBLE "SPA"
TUBING (\$/FOOT)**

467363	1-1/2"
467370	2"

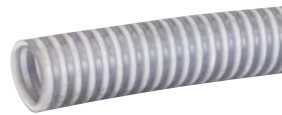

**PVC SUCTION
TUBING (\$/FOOT)**

368240	3/4"
368271	1"
366772	1-1/4"
368332	1-1/2"
368363	2"



**GUILLOTINE
VALVES**

464683	1"
464129	1-1/2"
464133	2"
464690	3"



**PVC
STRAPS**

470929	3/4"
470899	1"
470912	1-1/4"
470905	1-1/2"
470936	2"
471018	3"

POLYETHYLENE FITTINGS



**REGULAR
(INS X INS X INS)**

459931	1" x 1" x 3/4"
459955	1-1/4" x 1-1/4" x 1"
459979	1-1/2" x 1-1/2" x 1"
459993	1-1/2" x 1-1/2" x 1-1/4"
460210	2" x 2" x 1-1/2"



**REDUCERS
(INSERT X INSERT)**

459313	1" x 3/4"
459351	1-1/4" x 1"
459412	1-1/2" x 1-1/4"
459474	2" x 1-1/2"



**ELBOWS
(INSERT X INSERT)**

460852	3/4"
460890	1"
460913	1-1/4"
460937	1-1/2"
460951	2"



**MALE ADAPTORS
(INSERT X MNPT)**

461675	3/4"
461279	1"
461699	1-1/4"
461712	1-1/2"
461736	2"



**UNIONS
(INSERT X INSERT)**

462818	3/4"
462832	1"
462856	1-1/4"
462870	1-1/2"
462894	2"



**CAPS
(INSERT)**

500886	3/4"
500909	1"
500923	1-1/4"
500947	1-1/2"



**"T"
(INS X INS X INS)**

463013	3/4"
463037	1"
463051	1-1/4"
463075	1-1/2"
463099	2"



**"T" GREY ADAPTORS
(INS X INS X INS)**

461132	3/4" x 3/4" x 1/2"
461156	1" x 1" x 1/2"
461170	1-1/4" x 1-1/4" x 1/2"



**POLYETHYLENE
FITTINGS NO
RESTRICTIONS (UNIONS)**

468056	3/4"
468063	1"
468070	1-1/4"
468087	1-1/2"
468094	2"



**POLYETHYLENE
FITTINGS NO
RESTRICTIONS
(MALE ADAPTORS)**

468001	3/4"
468018	1"
468025	1-1/4"
468032	1-1/2"
468049	2"



**CLEAR PLASTIC
CHECK VALVES
(FIPT)**

405440	1"
405457	1-1/4"
383991	1-1/2"
384042	2"



**CLEAR PLASTIC
CHECK VALVES
(SLIP X SLIP)**

383861	1"
383878	1-1/2"
383892	2"
383915	3"

OTHER SIZES AVAILABLE IN BOTH MODELS

TOOLS

D&G TOOLS AND ACCESSORIES

A 480751 Support level line

LOWE CUTTER

B 480584 5/16" Lowe straight cutter

C 480522 5/16" Lowe cutter

D BRING TOGETHER HOOK

006630 5/16" - 3/16" automatic bring together hook

E APRON FOR FOREST WORK

475382 Orange

F LINE LEVELER

479892 Kuker Ranken hand level

LINE TAPPING MULTI-TOOL

467028 LineViper 3/16

G 467004 LineViper 5/16

GV SNOWSHOES, ALUMINUM FRAME

H 475443 9" x 29" (4102, Snow aerolite)

475467 10" x 36" (4103, Snow aerolite)

476334 11" x 28" (5546, Wide trail)

I 475481 11" x 38" (5548, Wide trail)

475894 12" x 33" (5547, Wide trail)

475504 12" x 42" (5549, Wide trail)

J 476310 9" x 30" (5821, Snow)

476327 10" x 36" (5822, Snow)

K 476341 9" x 29" (4124, Winter trail)

476358 10" x 36" (4125, Winter trail)

OTHER SNOWSHOE MODELS AVAILABLE



HIGH-DENSITY
ULTRA-DURABLE
FABRIC

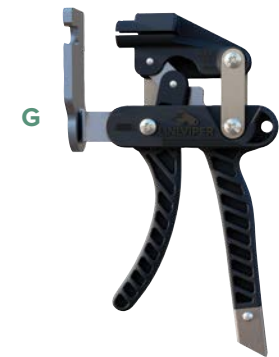

TOOLS

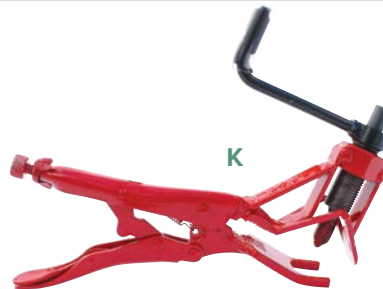
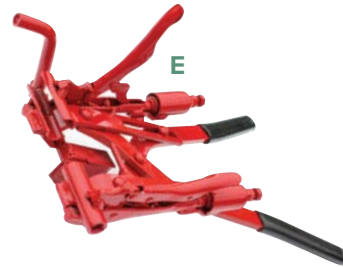
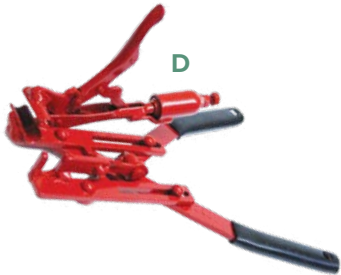

TOOLS

- A 480980** $\frac{3}{16}$ " compact insertion plier & vise grip (710651)
- 480690** 9" wire bender, with #9 and #12 spring (71576)
- B 480959** 11" wire bender, with #6 and #9 spring (71571)
- C 473975** $\frac{5}{16}$ " compact insertion plier & vise grip (71065)
- D 475160** Repair tool, automatic tension (71401)
- E 474934** Deluxe tubing drop plier (71106)
- F 480744** Electric rewinding hook (719991)
- G 480126** Small tubing repair plier (71050)
- H 480362** $\frac{3}{16}$ " small tubing repair plier (710501)
- I 480140** Spring for insertion plier (71051)
- J 474897** $\frac{31}{64}$ " metal punch (71300)
- K 471285** $\frac{3}{8}$ " metal punch (71315)
- 474903** $\frac{15}{32}$ " metal punch (for Plastech)
- L 470646** $\frac{3}{16}$ " - $\frac{5}{16}$ " bring together hook (71905)
- M 470639** $\frac{5}{16}$ " bring together hook (71904)
- N 473401** Reducer spout remover (71292)

SINGLE DRILL BIT

- 480607** 15/32", green (71311)
- 474828** 3/8", black (71316)
- A 474729** 3 1/64", red (71301)
- 474705** 7/16", blue (71321)
- 475764** 5/16", yellow (71331)

TUBING TOOLS AND ACCESSORIES

- B 476921** Cut vacuum plier, automatic tension (71919)
- C 475016** Tubing remover, four functions (71210)
- D 480447** 3/4" + 1" mainline plier(71500)
- E 480577** Horizontal reel, adjustable for wire and tubing (71625)
- F 475177** Horizontal 22" adjustable tubing reel (71610)

10 INCH ALUMINUM HAMMERS

- G 472800** Hammer and spout remover (71806)
- H 472817** Hammer and hatchet (71807)
- I 472824** Hammer and hatchet (71808)

TOOLS

- J 476907** 5/16" Installation plier with knife (71146)
- 476914** 3/16" Installation plier with knife (711081)
- 473999** 5/16" Installation plier without knife (71109)
- K 480904** 3/16" Installation plier without knife (711091)
- L 470943** 1/4" cone and gauge tester(71947)

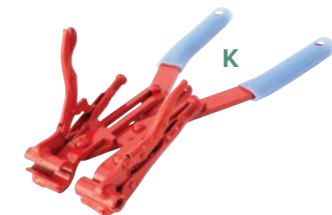
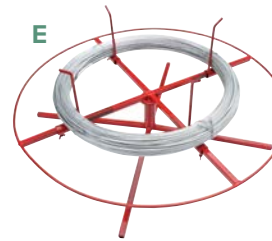
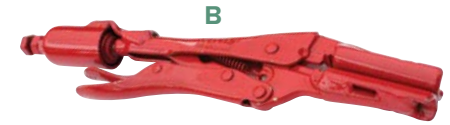

TAPPING

A



C



D



B

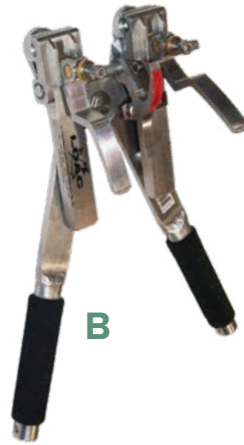

E



F



G



H



I



HAMMERS

- A **473876** 10" hammer with handle (2 faces)
- B **473920** $\frac{5}{16}$ " tubing aluminum plier
- 478604** $\frac{3}{16}$ " tubing aluminum plier

SPOUT REMOVERS

- C **473883** 15" spout remover (small)
- 474521** 22.5" spout remover (medium)
- 474033** 30" spout remover (tall)
- D **474583** 40" spout remover (x-tall)
- 476365** 48" spout remover (on request)

MAINLINE ADJUSTER

- E **477010** 30" mainline adjusting tool

OTHER D&G TOOLS AND ACCESSORIES

- F **155284** Garant pruner
- G **474835** $1\frac{1}{2}$ " plastic mainline cutter
- 474859** 2" plastic mainline cutter
- H **466243** Knipex plier for high tension #10 wire
- I **466359** CHAMBERLAND Drop line plier

SURVEYOR TAPE

- 149733** Neon orange
- 149900** Neon Pink
- 149917** Neon blue
- 149924** Neon red
- 149740** Neon orange/black



DRILL BIT CRAFTSMANSHIP

FEATURES

Precise Split Point Clearance

The clearance at the tip of the drill bit enables precise penetration without distorting the hole, ensuring clear and accurate results.

Full-Length Deep Flute

The full-length deep flute allows for efficient accumulation of wood chips, reducing friction and enabling entry to the desired depth in a single operation.

Spiral Chip Relief Ellipse

The clever machining of the spiral chip relief ellipse retains wood chips inside the bit, ensuring complete evacuation upon removal from the tree.

Long-lasting Performance

Crafted with high-carbon steel, our drill bit stays sharper longer than most available on the market, ensuring exceptional durability.

USAGE TIPS

Ensure Sharpness

Ensure the side lips of the drill bit are sharp. Well-sharpened side lips guarantee precise cutting, enhancing harvest quality.

Minimal Sharpening

To ensure increased durability, avoid sharpening the drill bit more than twice. This ensures consistent performance and extends the tool's lifespan.

TAPPING DRILLS

DOMINION & GRIMM

G	474668	5/16" regular length
H	474644	19/64" regular length
I	472008	1/4" regular length
J	474682	7/16" regular, special right
	478956	19/64" short length
	478963	5/16" short length
	474484	1/4" short length

MICHES BOLDUC

M	475047	19/64" regular length
	475009	5/16" regular length
	476747	1/4" regular length
K	478987	19/16" short length
L	478994	5/16" short length
N	478970	1/4" short length



SHARPENING SERVICES AVAILABLE IN STORE



O	470547	7/16" tapping bit stopper (71910)
	470561	5/16" tapping bit stopper (71911)
	470523	19/64" tapping bit stopper (71912)
P	409035	tapping bit stopper (71918)

DRUMS

IMPORTANT TO MAINTAIN A HIGH TEMPERATURE IN THE BARREL BEFORE CLOSING

A



B



C



D



E



F

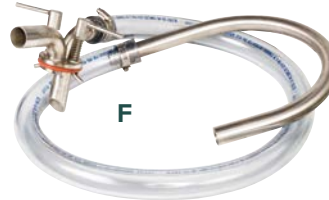

H



G



STAINLESS STEEL DRUMS

- A **472695** 34 gallons
- 473067** 40 gallons
- 499692** 2" stainless steel plug for above
- 952036** 2" nylon gasket for stainless steel
- 473135** Drum wrench
- 499708** Reducing drum plug for 3/4" plug
- 499685** 2" TRI-SURE zing plug for drum
- 473050** 2" irradiated gasket for drum

B HEATING BELT, 1200 WATTS

- 266492** Keeps or warms your barrels (not completely filled)
- Ensure your barrels are packaged at a minimum temperature of 180°F
- Thermostat 0 - 375°F
- Runs on 110/120 Volts 15 Amps
- Length of 58.5", for 34 gallons barrels

C BARIL LITHO D&G

- 473111** 34 gallons stainless steel (PERSONALIZATION POSSIBLE)

D DRUM ROCKER

- For moving, draining, or storing drums up to 45 gallons.
- 473210** 1000 lb capacity

E DRUM TRUCK

- Designed to handle containers from 18" in diameter to large 45 gallons drums.
- 473234** 1000 lb capacity

F DRUM TRANSFER

- Lets you switch from one drum to another during filling. Helps avoid overflow.
- 402074** 1/2"
- 402470** 1" stainless steel

DRUM PIPES

- G **006531** 1/2" "U" pipe with hook positioning
- F **006524** 1/2" "U" pipe SS for filling drum
- 006517** 3/4" "U" pipe SS for filling drum
- 006487** 1" "U" pipe SS for filling drum

CLEANING YOUR EQUIPMENT IS THE KEY TO PRODUCING QUALITY SYRUP AND PROTECTING YOUR EQUIPMENT.

After using your pans, it's important to thoroughly clean them of accumulated limescale deposits, just as you would your pots and pans in the kitchen.

The build-up and types of deposits vary from region to region. After 3-4 hours of boiling, it's advisable to clean or replace with clean pans, and take the time to clean the soot from underneath your pans and dishes.

The build-up acts as a thermal barrier and can reduce the intensity of boiling. Cleanliness increases your chances of making quality syrup and the performance of your equipment.

AFTER 3-4 HOURS OF BOILING, IT'S ADVISABLE TO CLEAN OR REPLACE WITH CLEAN PANS

PAN CLEANERS



LIQUID PAN CLEANER

J 477898 4 litres, liquid pan cleaner

K 478048 20 litres, liquid pan cleaner
Agriculture Canada Approved. Biodegradable products. Liquid cleaners for evaporators.

L 477393 4L "Finox" creosote cleaner



"SUPER CLEAN" CLEANER

M 477423 3.78 litres, "Super Clean" liquid cleaner for pans

477430 20 litres, "Super Clean" liquid cleaner for pans

"MYSTER PAN" CLEANER

N 478192 4 litres, "Myster Pan" liquid cleaner

478208 20 litres, "Myster Pan" liquid cleaner



CLEANERS

OSMOSIS CLEANERS



TUBING CLEANERS



MEMBRANE CLEANING PRODUCTS

- A **472718** Pearl ALKALINE cleaner (2 kg)
- 478277** Pearl ALKALINE cleaner (20 kg)
- B **361449** Bio Perm - Suitable for **organic** production (4 litres)
- C **472732** Bio Perm - Suitable for **organic** production (20 litres)
- D **478055** Acid cleaner in powder, Acid-osmosis (2 kg)
- E **361418** Sanitizing Oxisan - peracetic acid (4 litres)
- 139437** Sanitizing Oxisan - peracetic acid (20 litres)
- 139444** Sanitizing Oxisan - peracetic acid (55litres)
- 132063** Sanitizing Oxisan - peracetic acid (205 litres)
- F **359453** Glycol concentrated food antifreeze (4 litres)
- 359033** Glycol concentrated food antifreeze (20 litres)
- G **477751** Anti-bacteria, for storage, for membrane (1 kg S.M.B.S.)

H PH TEST STRIPS

For checking the PH of your washing solution
133381 PH test strip (set of 10)

DENATURED ALCOHOL

477843 Disinfects tapping drills and spouts, 4 liters (2-J)

ISOPROPYL ALCOHOL

- I **420269** 70% isopropyl alcohol, 3.78 litres
- 420276** 70% isopropyl alcohol, 18.9 litres
- 424946** 70% isopropyl alcohol, 205 litres (45 gallons) drum (Non-returnable drums)
- 477201** Container and adjustable strap only
- 477225** Seal for syringe gun
- J **477379** 5 litre container kit with adjustable straps
- K **477386** 15ml feed regulator plastic gun (only)

CHLORINE

- L **420290** 20 litres, chlorine disinfectant
- 420283** Empty container for chlorine (returnable)

CLEANING TIPS



ACID SOLUTION FOR MINERAL REMOVAL

An acid-based solution will help dissolve minerals so that they can be removed from the membrane.

The membrane material tightens in acid solution, making the pores tight and rigid.

After an acid wash, a quick wash in an alkaline solution followed by a good rinse will restore the membrane to the desired level of concentration.

AFTER USING THE CONCENTRATION CYCLE

- Desugaring
- 3-4 minute rinse
- Soap (PH 12), 3-4oz/membrane (or 1-2oz/membrane for 4" membrane)
- Rinse 3-4 minutes
- Hot water loop (optional)
- 3-4 minute rinse
- Hot water loop (optional)
- Final rinse 15-20 minutes

ALKALINE SOLUTIONS WILL HELP ELIMINATE BACTERIA AND ORGANIC MATTER

Washing is done in a NaOH (Sodium Hydroxide) solution to remove bacteria and organic matter.

It is important to follow your manufacturer's instructions for the use of available solutions.

Alkaline solutions (soaps) set membrane

materials to high porosity. Your wash cycles should always be at low pressure. Be sure to rinse well before concentrating. It's important to maintain a soapy load with a **maximum pH of 12**.

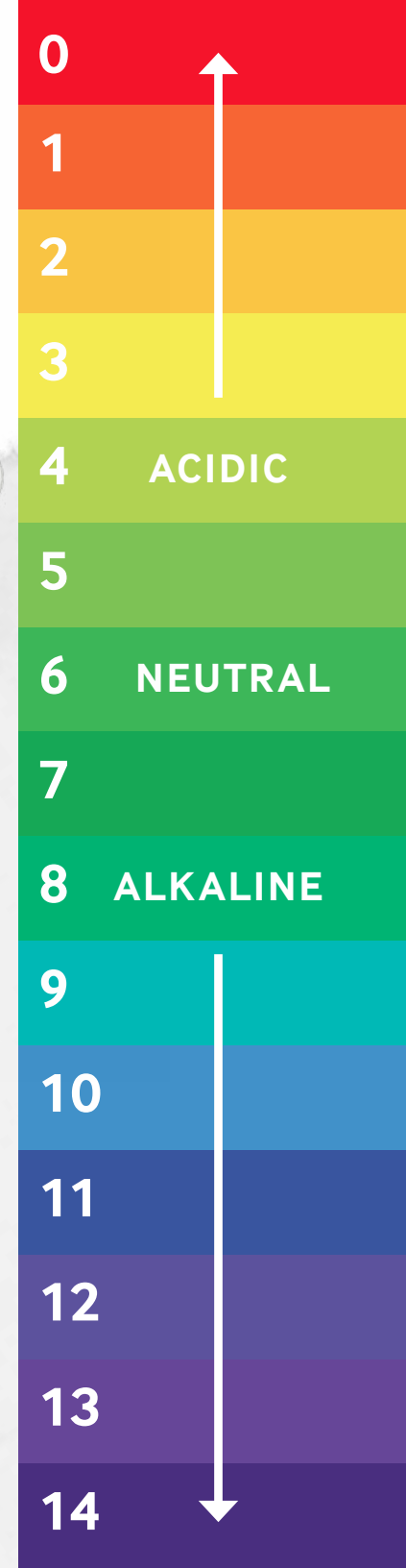

BRUSHES & GLOVES

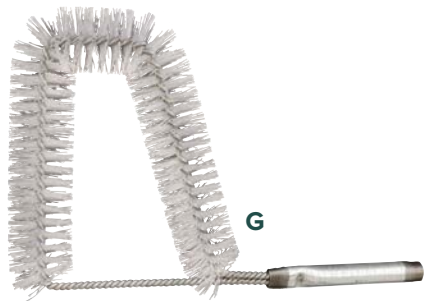

BRUSHES

- A 475573** 7/16" for drill
- B 475597** 7/16" with eyelet
- C 475702** For 5/16" and 19/64" eco spout
- D 475696** N° 99 fiber brush, for 7" flue
- E 475672** Nylon N° 97 flues
- F 475658** 1/2" special, nylon (small flue)
- G 436543** N° 98 for underneath 2" flue pan
- H 475795** Brush for 1.5 and 2 gallons bucket washer. Used with a drill

I THERMAL GLOVES

Breathable polyurethane coating. Insulated acrylic liner.

- | | |
|----------------------|------------------------|
| 486654 Medium | 486678 X-Large |
| 486630 Large | 486647 XX-Large |

ACCESSORIES

A MOULDS

Various candy, lollipop and sugar moulds available. Check your local D&G store or our website for models and availability.

FDA LOLLIPOP MOULDS

- B 488757** Barrel with maple leaf, clear (12 cavities)
C 488771 Maple leaf (12 cavities)

D CONES

- 452581** 900 per box
452574 1914 per box

E CONE TABLES

- Made with polyethylene
489105 For mini cones, 60 cavities (white)
489921 12 cavities
489938 24 cavities
489945 36 cavities
489952 48 cavities

LITHOGRAPHED CONE BOXES WITH CLEAR TOP

Bush scene design, space to inscribe producer's name. 100 per box.

- F 452857** For 6 cones (Brown)
452888 For 12 cones (Brown)
410574 For 6 cones (White)
G 410581 For 12 cones (White)

WHITE CONE BOXES WITH OPEN CLEAR TOP (NOT SHOWN)

- 100 per box
452611 For 6 cones
452765 For 12 cones

H SUGAR MOULDS

- 268625** 250 g adjustable table, 35 moulds
268656 500 g adjustable table, 24 moulds
487989 Table only
268687 250 g moulds only, separators included
268717 500 g moulds only, separators included

I CELLOPHANE BAGS

- 100 per box
487675 4 oz (2.5" x 1" x 6")
487552 375g, for lollipops (2.5" x 1.25" x 7")
487583 1 lb (3.25" x 1.25" x 8.5")
487590 1.5 lb (3.5" x 1.25" x 9")

J SEALING WAX BLOCS

- 489020** Red (1kg) **489044** Gold (1kg)
488979 Silver (1kg) **489518** Black (1kg)
488993 Blue (1kg) **489556** White (1lb)

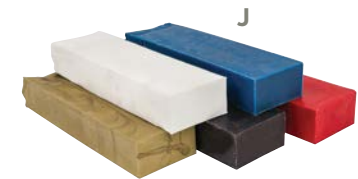
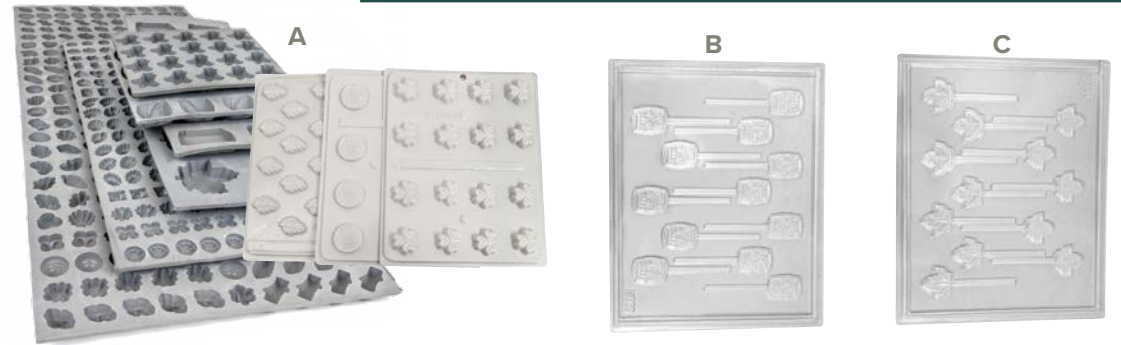

ACCESSORIES

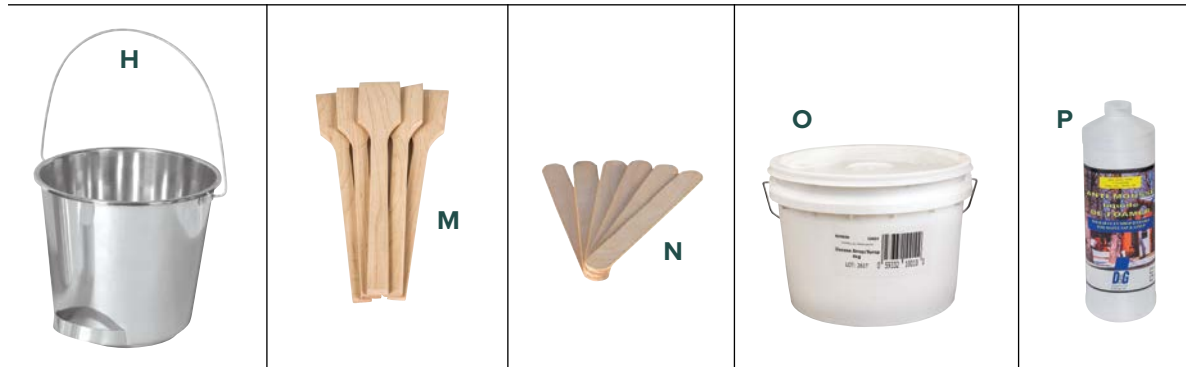

MISCELLANEOUS

A 602887 DG Candle - Maple Syrup Scented

GRADING SETS

- B 117435** Grading set, new classes Valid for two years.
495182 Additional empty bottles
C 117312 Lovibond grading set, Complete
D 117329 Lovibond color wheel, IMSI
E 117510 Lovibond optical glass (only)
F 117503 Lovibond support (only)

ACCESSORIES FOR HANNA TESTER

- G 122415** Maple Syrup Digital Grader (HI759)
122422 Test tubes, 25/package (HI759)
115622 Disposable test tube, 100/package (HI96759)
115615 Disposable pipette, 50/package
117183 450 ml Glycerin for Hanna Tester

H STAINLESS STEEL PAIL

470066 3 gallons

DRUM FUNNEL (NOT SHOWN)

473159 Drum funnel

HEAVY PADDLES MADE OF MAPLE WOOD

- I 490125** 42"
J 490002 24" Old-fashioned model
K 490026 18" Old-fashioned model
L 490040 12" Old-fashioned model

TAFFY STICKS MADE OF MAPLE WOOD

- M 490057** 10", 12 per package
490033 6", 12 per package
N 489129 Tongue depressors (500/cs)

O GLUCOSE

- 477539** 20 litres
477553 4 litres

DEFOAMER, KOSHER

- P 477614** 1 litre, liquid
477621 4 litres, liquid
Q 477591 200 g, powder
R 477560 2.5 Kilo, powder

DEFOAMER

- S 478925** Sunflower oil, bio, deodorized 1 litre
477140 Sunflower oil, bio, deodorized 4 litres
477645 Sunflower oil, bio, deodorized 16.5 litres
T 267024 Stainless steel spoon for defoamer

U D&G GENUGEL

- Gelatine to produce maple jelly. Approximately one jar of 250 ml / g
477577 200 g

V SUCROVERT

- To invert syrup which has to be transformed into sub-products.
498541 465 ml

MAPLE SAP DENSIMETER

- A 116599** * Densimeter, 0° - 8.5° Brix (2010)
- B 116391** * Densimeter, 0° - 15° Brix (1755)
- C 116612** * Densimeter, 8° - 23° Brix
- D 116629** * Syrup densimeter (2075). 35° - 75° Brix & baume, 59° hot syrup, 66° cold syrup
- 267666** * Syrup densimeter (2075) with certified calibration

2000 HYDROTHERM

Will give you reading between 35°F and 210°F. Pre-calibration at 65.8° Brix. Combination of a hydrometer and a thermometer

- E 115998** * Alla Hydrotherm
- F 470202** * Strong Kessler Hydrotherm

HYDROMETER CUPS

- G 267727** Height: 10", diameter: 1 1/2"
- H 267758** Height: 10", diameter 2"

THERMOMETERS

- I 116025** * Red drop D&G thermometer
- J 116056** * Refill for D&G red drop thermometer
- K 116124** * Digital thermometer, for candies

BRIX REFRACTOMETERS

Included: An adjustment screwdriver, a rag, pipettes and carrying case.

- L 116636** * Alla 1st quality, 0° - 32° Brix
- 116582** * Alla 1st quality, 45° - 82° Brix
- 116575** * Alla 1st quality, 58° - 90° Brix
- 116537** 15 ml calibration liquid for refractometer 58° - 90°
For 15ml refractometer, 58° to 90° (not shown)
- M 357459** Atago Pal-Maple 0° - 85° Brix refractometer
- 117398** Atago invert sugar refractometer

INDUSTRIAL QUALITY DIAL THERMOMETERS

Tempered glass. These dial thermometers are 1/4" mpt

- 115783** *12" x 5" dial thermometer (0°F - 50°F)
- 115813** *9" x 5" dial thermometer (0°F - 50°F)
- 115844** *9" x 3" dial thermometer (0°F - 50°F)
- 115875** *12" x 3" dial thermometer (0°F - 50°F)
- 115936** *18" long prob dial thermometer (0°F - 50°F)
- 206634** Bracket for pan (not shown)

INSTRUMENTS

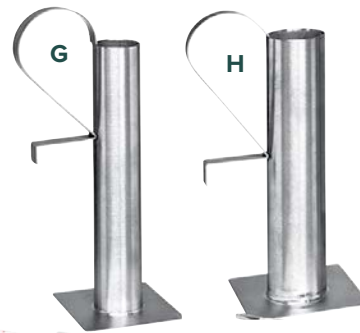



A



B

COMPLIANT WITH THE CALIFORNIA LEAD REGULATIONS



C



D



E

PLUMBING WITH SANITARY FITTINGS

A DOMINION MAPLE CREAM MACHINE

Mixer holding up to 2 gallons of maple syrup. $\frac{3}{4}$ hp 110 Volts electric motor. 1" lead free brass "Oberdorfer" gear pump. All stainless steel plumbing on ferrules with fittings fully removable for a quick cleaning of the tank and the plumbing.

- 264306** Mixer for maple cream
- 053283** 2" Silicone gasket
- 264313** Stainless steel arm to clean & empty cream machine pipe

B DOMINION & GRIMM CREAM MIXER

$\frac{1}{2}$ hp 110 Volts electric motor with a gear box
Compact and robust construction
Completely made in stainless steel
Holes in the paddles for better mix

- 265747** Cream mixer
- 206306** 16" x 6" Additional sugar pan

WATER BATH BOTTLERS, STAINLESS STEEL STAINLESS STEEL 304

To maintain temperature or warm syrup before bottling.

- C 266256** 34-gallon bain-marie bottle
Includes: 5000W heating element - 220V, adjustable thermostat, all stainless steel plumbing, stainless steel base, adjustable shelf, acrylic level for water and syrup.
- 266201** Base and countertop (stainless steel. 34 gallons)

SQUARE BAIN-MARIE BOTTLERS (35 GALLONS)

- D 266423** 35 gallon bain-marie bottle
- 266355** Stainless steel base
- E 266218** 9-gallon water bath bottle
Includes: 3000W heating element - 220V, adjustable thermostat, all stainless steel plumbing, stainless steel base, adjustable shelf, acrylic level for water and syrup.
- 266300** Base and countertop (stainless steel. 9 gallons)

HEATING ELEMENTS (NOT SHOWN)

- 111945** 5000 Watts
- 111914** 3000 Watts
- 095559** Dial thermometer 3" x 6" connection 1/2 (0°F to 250°F)

GUMMED LABELS, 4 COLOURS

Bush scene design, 500/Roll

- | | | | |
|-----------------|---------------------|-----------------|------------------------|
| A 493201 | Vertical, for 375ml | C 493621 | Small, no volume |
| 493423 | 125ml | 493645 | Large, no volume |
| B 493485 | 250ml | D 493393 | Clear, large |
| 493508 | 500ml | 493669 | Mini |
| 493546 | 1 Litre | 493157 | Clear, mini (100/Roll) |

E MAPLE LEAF STICKER

Gold maple leaf with clear background.
Completes your package.

493522 500/Roll

NUTRITION FACTS TABLE STICKERS (NOT SHOWN)

500/Roll

- 493904** Large
493911 Medium
453083 Butter, 200/Roll
453090 Tire, 200/Roll

PERSONALIZED LABELS (MINIMUM OF 1000)

Printed with customer's name. For syrup cans or any other container used for maple syrup products.

- F 493447** 15/16" x 2 11/16" sugar bush design
493355 Bar code, without pattern

GRADE STICKERS (CANADA)

500/Roll

- G 492785** Gold with delicate taste (+ 75 % Transmission of light)
H 492778 Amber with rich taste (50 % - 74.9 % Transmission of light)
I 492761 Dark with robust taste (25 % - 49.9 % Transmission of light)
J 492754 Very dark with strong taste (-25 % Transmission of light)

GRADE STICKERS (ONTARIO)

500/Roll

- K 492655** Gold with delicate taste(+ 75 % Transmission of light)
L 492662 Amber with rich taste(50 % - 74.9 % Transmission of light)
M 492679 Dark with robust taste (25 % - 49.9 % Transmission of light)
N 492686 Very dark with strong taste(- 25 % Transmission of light)

DECORATIVE CARDS, 100/BAG

Bilingual decorative cards with nutrition facts for maple syrup

- O 452475** Sugar bush scene with elasti-band
P 493713 Tamper evident gold foil sticker (1000/Roll)

STICKERS

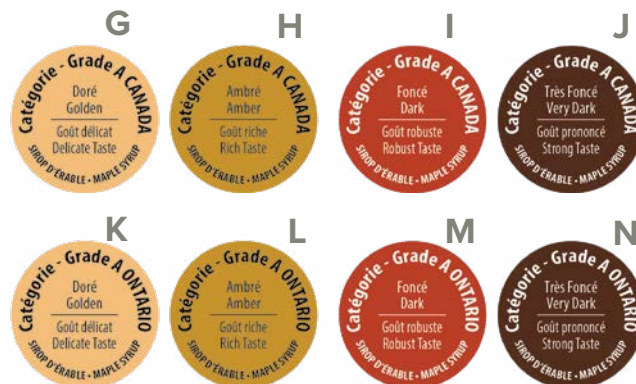
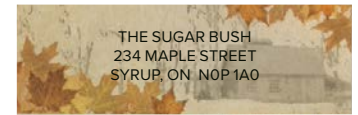



METAL LITHOGRAPHED CONTAINERS

With metal screw caps

- A **500107** 100 ml (216 / box)
- B **500077** 250 ml (65 / box)
- C **500053** 500 ml (35/box)
- D **500039** 1 Litre (24/box)

METAL CAPS FOR LITHOGRAPHED CONTAINERS

- 522024** Gold for 100 ml., 18 mm
- 522109** Gold for 250 ml and 500 ml., 25 mm
- 522031** Gold for 1 Litre., 38 mm
- 593000** Black metal button, 38 mm



CAN SEALERS

- I **536304** DIXIE" automatic – electric
- J **470332** "MASTER" automatic – electric
- K **470295** "MASTER" automatic – manual
- L **470363** "Yves way" automatic – manual

EVOLUTION OF THE CAN

SPECIAL PRICING ON CANS

A



B



C

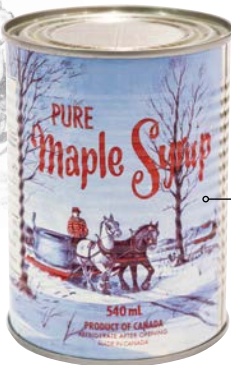

D



E



H



F

G

Icon of the maple industry, the famous 540ml can of syrup has managed to stand the test of time.

These little cans appeared in 1951 when the Quebec Ministry of Agriculture set up a drawing contest to promote their use. The cans, then with a volume of 19oz liquid, were of a more versatile format for Quebec households than the tin cans whose formats varied from 1L to 4L. Despite the contest, the small format is still available while the larger one was available until about 2005.

When we talk about maple syrup, the D&G Classic can is the image that comes to mind. It was designed by the founder of Dominion & Grimm, Mr. Sylva Lebrun, during the 1950s. Since then, it has been accompanied by other images, including the "Vintage" which appeared around the same time as the "Classic".

Did you know that Quebec is the place where the most maple syrup is canned? In other producing territories, the use of glass and plastic containers dominates maple syrup packaging.

SPECIAL PRICING ON ALL CANS

Covers included, 200 / case

- A 452918 540 ml, D&G classic
- 453991 540 ml, D&G classic, economical
- B 454165 540 ml, Quebec, Organic, 4 colours
- C 453984 540 ml, Canada "Vintage"
- 520297 540 ml, Canada, sugar bush scene, economical
- 524714 N° 307, metal covers (only)

540ML RESHIPING BOXES

- E 450990 4 x 540 mL..... 25 / bundle
- F 452086 8 x 540 ml..... 25 / bundle
- 487743 8 x 540 ml (brown)..... 25 / bundle
- G 452222 8 x 540 ml with handle..... 50 / bundle
- H 452055 24 x 540 ml..... 25 / bundle

JUGS

PLAIN JUGS
AVAILABLE

NEW DESIGN



NEW DESIGN

SPECIAL JUG PRICING
PER QUANTITY

A CANADIAN PLASTIC JUGS

Plastic light brown with colourful label. Nutrition facts included.

Caps not included.

490170	100ml (28PP), 300/box	454264	1L (38PP), 100/box
500480	250ml (38PP), 100/box	454295	2L (38PP), 50/box
500541	500ml (38PP), 100/box	452840	4L (38PP), 24/box

B OMSPA PLASTIC JUGS

Plastic light brown with colourful label. Nutrition facts included.

Caps not included.

454202	100ml (28PP), 300/box	454271	1L (38PP), 100/box
454226	250ml (38PP), 100/box	452772	2L (38PP), 50/box
500145	500ml (38PP), 100/box	452871	4L (38PP), 24/box

PLAIN PLASTIC JUGS

Plastic light brown, without a label. **Caps not included.**

454219	100ml (28PP), 350/box	454288	1L (38PP), 90/box
499890	250ml (38PP), 350/box	452833	2L (38PP), 50/box
454257	500ml (38PP), 196/box	452895	4L (38PP), 24/box

TAMPER EVIDENT CAPS FOR JUGS

590559	28PP Brown	590443	38PP Brown
590542	28PP Red	589942	38PP Red



LITHOGRAPHED BUTTER & TAFFY CONTAINERS

Comes with lid and nutrition facts. 500/box

C 491085	Butter, Canada (250g)	491108	Taffy, Canada (250g)
491023	Butter, Canada (500g)	D 491207	Taffy, Canada (500g)
		494666	Taffy, Canada (250g)

NON-TAMPER EVIDENT LITHOGRAPHED CONTAINERS

Comes with lid and nutrition facts.

G 431531	Butter, Canada (250g)	431524	Taffy, Canada (250g)
495106	Butter, Canada (500g)	H 495090	Taffy, Canada (500g)



LITHOGRAPHED BUTTER & TAFFY CONTAINERS

Comes with lid and nutrition facts. 500/box

H 454066	Butter, Canada (250g)	I 454073	Taffy, Canada (250g)
J 454080	Butter, Canada (500g)	K 454097	Taffy, Canada (500g)



DISCOVER OUR FULL RANGE OF BOTTLES & JARS IN THE PACKAGING BROCHURE ON OUR WEBSITE WWW.DOMINIONGRIMM.CA

GLASS BOTTLES



SYRUP BOTTLES WITH HANDLES

- A 503832** 250ml (28PP), 12/box
- 495700** 375ml (28PP), 12/box
- 505218** 500ml (28PP), 12/box



ROUND BOTTLE

- B 502002** 1L (28PP), 12/box



TAMPER EVIDENT WHISKEY BOTTLES

- 501661** 750ml (28-400), 12/box
- C 502064** 1L (28-400), 12/box
- D 502958** 1L (28PP), 12/box



GALLONE BOTTLES

- 502279** 50ml (18PP), 96/box
- E 499401** 250ml (31.5PP), 12/box
- 495625** 500ml (31.5PP), 12/box
- 495663** 1L (31.5PP), 6/box
- 503313** 64oz (38-400), 6/box
- 503320** 128oz (38-400), 4/box



TONDO BOTTLES

- 499463** 100ml (28PP), 12/box
- F 432804** 250ml (28PP), 12/box
- 432811** 500ml (28PP), 12/box



FOLIA BOTTLES

- G 432439** 250ml (28-400), 12/box
- 432446** 500ml (28-400), 12/box



MAPLE LEAF BOTTLES

- 498619** 50ml (18PP), 48/box
- H 498633** 100ml (24PP), 12/box
- 498602** 250ml (24PP), 12/box
- 498749** 500ml (28PP), 12/box



LEO BOTTLES

- I 432514** 50ml (18PP), 104/box
- J 453601** 200ml (28PP), 12/box
- K 504259** 375ml (28PP), 12/box

GLASS BOTTLES



SPECIALTY BOTTLES

- A 482823** 200ml Hockey Player (28pp), 12/box
B 453977 250ml Basquaise (31.5PP), 12/box
C 504310 250ml Chalet (28PP), 12/box



SNOWMAN BOTTLE

- D 453014** 375ml (28PP), 12/box



ICE BOTTLES

- E 498435** 50ml (18PP), 96/box
F 432767 200ml (31.5PP), 12/box



CERAMIC ARTISAN JUGS

- G 499449** White label, 540ml (Cork included)
H 499470 Black label, 540ml (Cork included)

IT'S COMING BACK!

JUNE 2025



TARQUINA BOTTLES

- J 503655** 100ml (28-400), 12/box
I 503672 250ml (28-400), 12/box



SPICE SHAKERS

- K 589201** 100ml (43-485), 165/box
L 589225 8.4oz (53-485), 285/box
M 589232 16oz (63-485), 288/box



LIDS FOR SPICE SHAKERS

- N 589256** 43-485 red flapper with 5 holes, 1400/box
589386 43-485 black flapper with 5 holes, 1400/box
O 589263 53-485 red 2 flappers; 3 holes / 7 holes, 850/box
P 589287 53-485 white 2 flappers; 3 holes / spoon, 850/box
589195 53-485 black 2 flappers; 3 holes / spoon, 850/box
Q 589294 63-485 red 2 flappers; 7 holes / spoon, 750/box
R 589379 63-485 black 2 flappers; 3 holes / spoon, 600/box

CAPS & COVERS



REGULAR PLASTIC CAPS

	590139	Black, 22-400, 4700/box
	589690	White, 24-400, 3900/box
A	590078	Brown, 24-400, 3900/box
	590023	Black, 28-400, 5000/box
B	589966	White, 28-400, 4250/box
	589782	Brown, 28-400, 5000/box
	590207	Black, 31.5, 4150/box
	590450	White (Tri-Foam), 38-400, 3100/box
	590467	Black (Tri-Foam), 38-400, 3100/box



TAMPER EVIDENT PLASTIC CAPS

	590481	Black, 18PP, 3000/box		590375	Gold, 28PP, 3000/box
	590313	Gold, 18PP, 3000/box		504822	Black, 28PP, 3000/box
	590016	Black, 24PP, 2000/box	D	589768	Black with pour spout (I), 31.5PP, 1600/box
	590368	Gold, 24PP, 2000/box		590160	Black with pour spout (C), 31.5PP, 1600/box
	590009	Black, 28PP, 2300/box		589799	Black, 31.5PP, 1600/box
C	589485	White, 28PP, 2300/box	E	590030	Gold, 31.5PP, 1600/box
	590559	Brown, 28PP, 2300/box		590443	Brown, 38PP, 1600/box
	590580	Gold, 28PP, 2300/box		589942	Red, 38PP, 1600/box
	590542	Red, 28PP, 2300/box			



METAL CONTINUOUS THREAD CAPS

F	591716	Gold, 38-400, 3400/box
G	591686	White, 38-400, 3400/box
H	591693	Black, 38-400, 3400/box



METAL COVERS

593024	Black, 38mm, 3700/box	593246	Black, 53mm, 1750/box	593482	White, 63mm, 1200/box	593567	Pink Flower, 70mm, 1050/box	593727	White, 89mm, 600/box
593031	Gold, 38mm, 3700/box	593277	Gold, 53mm, 1750/box	593444	Silver p.b., 63mm, 1200/box	522451	Yellow Flower, 70mm, 1050/box	592041	White, 100mm, 390/box
593062	White, 38mm, 3700/box	593307	White, 53mm, 1750/box	590696	Silver, 63mm, 1430/box	I 593604	Black, 82mm, 725/box	592058	Gold, 100mm, 390/box
593093	Black, 43mm, 3400/box	590917	Silver, 53mm, 2000/box	482595	Honeycomb, 63mm, 1200/box	J 593635	Gold, 82mm, 725/box	593758	Gold, 110mm, 270/box
593123	Gold, 43mm, 3400/box	593338	Black, 58mm, 1575/box	590702	Silver, 70mm, 1050/box	K 593666	White, 82mm, 725/box	593765	White, 110mm, 270/box
593154	White, 43mm, 3400/box	593369	Gold, 58mm, 1575/box	593512	Black, 70mm, 1050/box	L 593659	Silver, 82mm, 725/box		
593116	Silver, 43mm, 3400/box	593390	White, 58mm, 1575/box	593543	Gold, 70mm, 1050/box	M 593680	Honeycomb, 82mm, 725/box		
593048	Black, 48mm, 2700/box	593611	Honeycomb, 58mm, 1575/box	593574	White, 70mm, 1050/box	593628	Gold p.b., 82mm, 725/box		
593185	Gold, 48mm, 2700/box	593376	Silver, 58mm, 1575/box	593505	Silver p.b., 70mm, 1050/box	N 593710	Pink Flower, 82mm, 725/box		
593215	White, 48mm, 2700/box	593420	Black, 58mm, 1575/box	593499	Gold p.b., 70mm, 1050/box	O 482649	Yellow Flower, 82mm, 725/box		
590665	Silver, 48mm, 2700/box	593451	Gold, 63mm, 1200/box	593673	Honeycomb, 70mm, 1050/box	593697	Gold, 89mm, 600/box		

HONEY PACKAGING



PLASTIC OBA SKEP BOTTLES

- A 583346** 500g (38-400), 12/box
- 583315** 1Kg (38-400), 12/box
- 590887** 38-400 yellow flip-top caps with liner, 2000/box

PLASTIC HONEY BEARS

- B 558320** 375g, 2 Panels, (38-400), 240/box
- 558344** 375g, 1 Panel, (38-400), 240/box
- 590887** 38-400 yellow flip-top caps with liner, 2000/box

MIELE JARS

- 494963** 500g (70mm), 12/box
- D 494970** 1Kg (82mm), 12/box

"HUNNY" JARS

- 499265** 212ml (DTO 63x14), 12/box
- 499296** Black DTO 63x14 Cap, 900/box
- 499319** Gold DTO 63x14 Cap, 900/box
- E 499272** 390ml (DTO 63x14), 12/box
- 499333** Black DTO 63x14 Cap, 750/box
- 499326** GodI DTO 63x14 Cap, 750/box

GLASS BEAR

- F 432699** 280ml (63mm), 12/box



DISCOVER OUR FULL RANGE OF BOTTLES & JARS IN THE PACKAGING BROCHURE ON OUR WEBSITE WWW.DOMINIONGRIMM.CA

GLASS JARS



HEX JARS

- 497063** 45ml (43mm), 24/box
- 496943** 110ml (48mm), 12/box
- 496974** 190ml (58mm), 12/box
- 496981** 270ml (63mm), 12/box
- 504662** 390ml (70mm), 12/box



SQUARE JARS

- 494772** 125ml (53mm), 20/box
- 502415** 212ml (58mm), 12/box
- 499418** 314ml (63mm), 12/box



TURENNE JARS

- 497599** 100ml (70mm), 12/box
- 497537** 200ml (82mm), 12/box



ROUND JARS

- 503849** 106ml (70-DTO-18), 12/box
- 503894** 212ml (70-DTO-18), 12/box
- 504754** 314ml (70-DTO-18), 12/box
- 496127** 375ml (70-DTO-18), 12/box
- 504273** 580ml (70-DTO-18), 12/box



COVERS FOR ROUND JARS

- 593703** Black, 550/box
- 338460** Gold, 550/box
- 593161** Copper, 550/box
- 388613** Silver, 550/box



TALL JARS

- 497100** 250ml (53mm), 12/box
- 502378** 250ml (58mm), 12/box
- 497315** 375ml (58mm), 12/box
- 497124** 375ml (58mm), 12/box
- 497148** 500ml (63mm), 12/box
- 502453** 750ml (82mm), 12/bte
- 495076** 750ml (82mm), 12/box
- 502439** 1.5 Liire (82mm), 6/box



SHORT JARS

- 432705** 100ml (53mm), 12/box
- 503108** 190ml (63mm), 12/box
- 503177** 229ml (70mm), 12/box
- 497483** 250ml (70mm), 12/box
- 496882** 250ml (70mm), 12/box
- 496141** 375ml (70mm), 12/box
- 496905** 375ml (70mm), 12/box
- 431739** 500ml (82mm), 12/box
- 495021** 750ml (82mm), 12/box



SMALL JARS

- 432729** 20ml (43mm), 96/box
- 492228** 40ml (43mm), 96/box
- 497469** 60ml (48mm), 96/box
- 497032** 125ml (48mm), 12/box

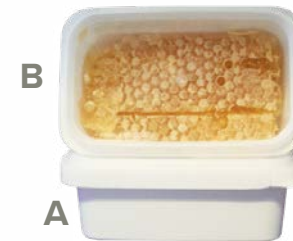

COMBED HONEY CONTAINERS

- 491559** 250ml aluminum (lids included), 1000/bte
- A 540257** 250g white rectangular TE container, 560/box
- B 239299** Clear rectangular lid, 1260/box



PLASTIC CONTAINERS

- C 540103** 500g TE graphic tub, 500/box
- 540127** 1 Kilo TE graphic tub, 456/box
- D 540486** Graphic lid, 1000/box



WHAT IS METHANISATION?

Methanisation is the transformation of organic matter into biogas, made up of methane and carbon dioxide by bacteria in an anaerobic environment (absence of oxygen). This degradation is only possible in the presence of fermentable matter: unstabilised sewage sludge, fresh sewage sludge and other organic waste such as manure, plant residues or food waste.

HOW IT WORKS

Methanisation takes place in a hermetically sealed reactor: the "digester" or "methaniser". In the absence of oxygen, the organic matter is partially degraded by the action of several types of micro-organisms, these bacteria being naturally present in fecal matter, and therefore in sewage sludge.



ECONOMIC ADVANTAGES

Advantages for the management of urban sewage sludge

- **REDUCE THE VOLUME OF SLUDGE BY 30 TO 40%:**
- Reducing and controlling operating costs, reducing the environmental impact of sludge transport and treatment, and reducing odour nuisance.
- **STABILISE AND HYGIENISE SLUDGE**
- **IMPROVE THE AGRICULTURAL VALUE OF THE SOIL, PARTICULARLY IN TERMS OF NITROGEN AND PHOSPHORUS, AND PRODUCE A MATERIAL THAT IS WELL ACCEPTED IN AGRICULTURE**

ENVIRONMENTAL AND AND SOCIAL BENEFITS

Advantages for the energy transition

- **PRODUCING RENEWABLE ENERGY AS A SUBSTITUTE FOR FOSSIL FUELS, HELPING TO ACHIEVE OUR OBJECTIVES THROUGH:**
 - Waste Management
 - Renewable Energy
 - Reducing Greenhouse Gas Emissions
- **REDUCE GHG EMISSIONS BY 80 TO 90%. BIOMETHANE USED AS A FUEL REDUCES PARTICULATE MATTER IN THE ATMOSPHERE BY MORE THAN 98% COMPARED WITH DIESEL FUEL, AND CUTS NOX EMISSIONS BY 80%**
- **GENERATING AND USING LOCAL ENERGY**



MANY CONVENIENT LOCATIONS

**NEW
STORE**

D&G DOMINION & GRIMM
TRADITION SINCE 1881

BARRIE, ON

**11,000 FT² WAREHOUSE FOR
PACKAGING CONTAINERS AND
MAPLE EQUIPMENT STORE**



ST. PROSPER, QC



VICTORIAVILLE, QC



DG USA



ANJOU, QC

AUTHORIZED DEALERS

DOMINION & GRIMM ONTARIO

T. 1.877.676.1914

dgonario@dominiongrimm.ca

D&G BARRIE

35 Morrow Rd, Barrie, ON L4N 3V7

(705) 798-3628

DOMINION & GRIMM NEW BRUNSWICK

6, rue Industrielle,

Saint-Quentin, N.B. E8A 2S5

T. 506.235.3001 / F. 506.235.9126

dgquentin@dominiongrimm.ca

DOMINION & GRIMM HEADQUARTERS

8250 Marconi, Anjou, Montréal, QC H1J 1B2

T. 514.351.3000

Email: info@dominiongrimm.ca

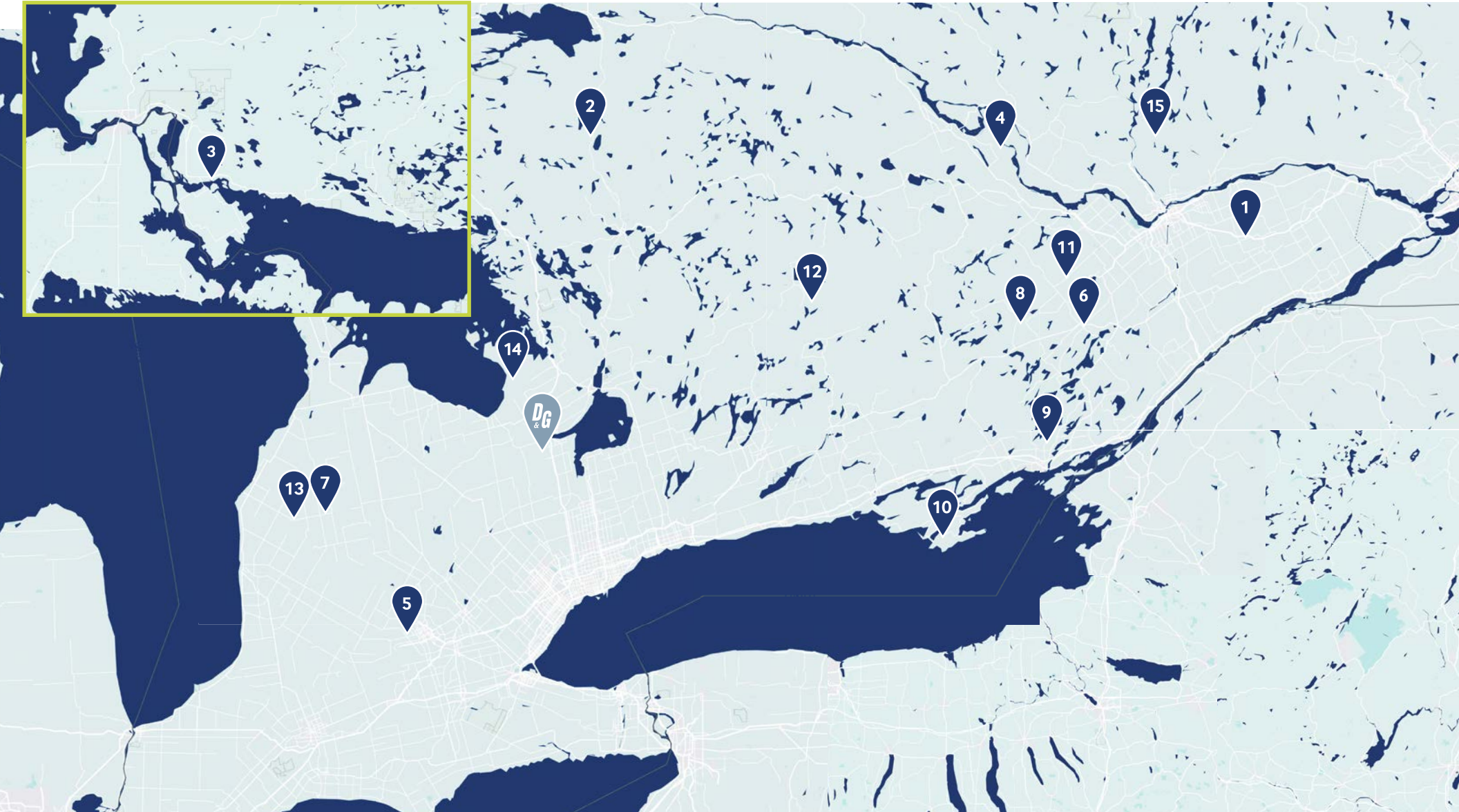

ONTARIO

- 1** **EMBRUN CO-OP**
755, Notre Dame Road
Embrun, ON K0A 1W0
T. 613.443.7662
- 2** **KIDD'S HOME HARDWARE**
23 John St., Sundridge, ON P0A 1Z0
T: 705.384.5365
info@kiddshomehardware.ca
- 3** **MCCLELLAND HARDWARE LTD**
3 Lake Huron Drive, Desbarats, ON P0R 1E0
T: 705.782.6281
mcclellandshardwareandfeed@gmail.com
- 4** **GRANTS SETTLEMENT FARMS**
43 Dittburner Rd., Forester Falls, ON K0J 1V0
T: 613.639.9567
jason@ggsfarms.ca
- 5** **WEBER'S SUGARBUSH SUPPLIES**
2844 Lobsinger Ln., Heidelberg, ON N0B 2M0
T: 519.699.4769
F: 519.699.5004
- 6** **PERTH HOME HARDWARE**
115 Drummond St. West,
Perth, ON K7H 2K8
T: 613.267.4501
michael.tooney@perthhhbc.com
- 7** **KLEIN'S MAPLE SYRUP**
126 Conc. 6E, RR#3, Mildmay, ON N0G 2J0
T: 519.367.2334
kleinmapleproducts@gmail.com
- 8** **MISSISSIPPI MAPLE**
1462 Shiner Rd.,
Mississippi Station, ON K0H 2C0
T: 613.585.6871
- 9** **MAPLE COUNTRY HOME & FARM LTD.**
3851 Davidson Rd., Inverary, ON K0H 1X0
T: 613.653.2000
maplecountryninverary@gmail.com
- 10** **VADER'S MAPLE EQUIPMENT**
1260 County Rd 18 RR#1, Cherry Valley, ON
K0K 1P0
T: 613.476.7537
vadersmaple@gmail.com

- 11** **SPRINGDALE MAPLE & EQUIPMENT**
1790 Galbraith Rd, RR#2, Clayton, ON K0A 1P0
T: 613.256.4045
info@springdalemaple.ca
- 12** **CAMP CAN-AQUA INC.**
503 Beaver Lake Dr., Cardiff, ON K0L 1M0
T: 613.339.2969
info@canaqua.ca
- 13** **CLEASON BAUMAN SYRUP SUPPLIES**
205 Kairshea Ave., Teeswater, ON N0G 2S0
T: 519.395.5062
- 14** **LAURIN MAPLE SYRUP SUPPLIES**
11 Dananne Dr., Tiny, ON L0L 2J0
T: 705.427.6766
peter@laurinmaplesyrupsupplies.ca
- 15** **ÉRABLIÈRE DU RUISSEAU**
4, chemin de la Montagne
Val des Monts, QC J8N 1B8
ssm3@sympatico.ca
T. 819.457.1335

NOVA SCOTIA

- 1** **UPPER BROOKFIELD FARMS & FORESTRY**
519 Upper Brookfield Road
Brookfield Nova Scotia, B0N 1C0
T. (902) 673-2588
- 2** **MARGAREE VALLEY MAPLE.**
119 Timmons Road, Margaree Valley,
Nova Scotia, B0E 2C0
T. 902.248.2631

NEW BRUNSWICK

- 3** **JAMES AND LISA MITTON**
5 Meadow Rd, Elgin, N.B. E4Z 1N7
T. 506.756.8690





POSTES		CANADA
CANADA		POST
	Port payé	Postage paid
	Courrier personnalisé	Personalized Mail
1134736		

PORT DE RETOUR GARANTI
RETURN POSTAGE GUARANTEED

THE ICONIC MAPLE SYRUP CAN

These little cans appeared in 1951 when the Quebec Ministry of Agriculture set up a drawing contest to promote their use. The cans, then with a volume of 19oz liquid, were of a more versatile format for Quebec households than the tin cans whose formats varied from 1L to 4L. Despite the contest, the small format is still available while the larger one was available until about 2005.



8250, Marconi, Anjou
Montréal, QC H1J 1B2
T 514.351.3000
info@dominiongrimm.ca
dominiongrimm.ca

